



MAY 31 2006

DepED MEMORANDUM
No. 197, s. 2006

108TH ANNIVERSARY OF THE PROCLAMATION OF PHILIPPINE INDEPENDENCE

To: Undersecretaries
Assistant Secretaries
Bureau Directors
Regional Directors
Directors of Services/Centers and Heads of Units
Schools Division/City Superintendents
Heads, Public and Private Elementary and Secondary Schools
All Others Concerned

1. The Department of Tourism (DOT) will spearhead the celebration for the 108th Anniversary of the Proclamation of Philippine Independence from May 28 (The National Flag Day) to June 30, 2006. This will be in collaboration with all the government agencies, private sectors and non-government organizations.
2. The objectives of this year's celebration are for the Filipino people to:
 - a. commemorate the heroism, patriotism, nationalism, and self-sacrifice of our forefathers in the struggle for independence; and
 - b. unite and rally behind the government and the country's institutions.
3. As co-chairman of the 2006 National Inter-Agency Task Force (NIATF), Secretary Fe A. Hidalgo with the DepED officials will participate in the programs and activities listed in the enclosure. These activities will be replicated nationwide in cooperation with the local government units and non-government organizations and associations.
4. All DepED regional, division, district and field offices both in public and private are hereby enjoined to conduct simple and fitting programs and requested to display and raise the Philippine National Flag on May 28 to June 30, 2006 for the Independence Day celebration. Peripheral activities for the Flag Day shall include a Flag in every home/office/major thoroughfares and Philippine embassies abroad, and a tarpaulin exhibit to be conducted by the National Historical Institute (NHI) in coordination with the Department of Education. The NHI will give six (6) sets of the Flag Day Exhibits through the DepED-Special Events Unit to be distributed to the different sites and venues. However, the Regional Special Events Coordinators will make schedule for the exhibits to travel from one region/division to the other:

Northern Luzon	- Regions I, II, III, and CAR
Southern Luzon	- Regions IV-Calabarzon, IV-Mimaropa, and V
Visayas Region	- Regions VI, VII, and VIII
Northern Mindanao	- Regions IX, X, and CARAGA
Southern Mindanao	- Regions XI, XII, and ARMM
One (1) set	- National Capital Region and DepED Central Office (SEU)

5. The Regional Special Events Coordinators will report to the DepED-Special Events Unit after the culmination of the exhibit in the last region/division on or before December 15, 2006.
6. As one of the highlights of this year's celebration, this Department will conduct a tour at the North and South Freedom Trail sites on June 9 and 10, 2006, respectively and on June 11, 2006, a workshop will be conducted to produce lesson exemplars that are anchored on the history and heritage of the Filipinos that contributed much in the proclamation of our Independence one hundred eight (108) years ago.
7. The tour and workshop will be participated in by the Regional Education Supervisor II in Social Studies (17) and Sibika/Hekasi (17); Education Program Specialists in BSE (Social Studies) (2) and BEE (Sibika/Hekasi) (2), Curriculum Development Divisions of which Dr. Merlita A. Nolido and Dr. Corazon L. Echano will serve as speakers during the workshop.
8. The travel expenses of the Regional Education Specialist II (Elementary/Secondary) shall be charged to local funds (such as but not limited to PTCA, local school board funds, regional/division funds) or may be sourced from civic spirited clubs, organizations and associations. Travel expenses of the Education Program Specialists from BEE and BSE shall be charged to their bureau funds while all other preparatory, actual expenses, such as board and lodging, documentation, extra duty allowance, and travel expenses of the Technical Working Committee shall be charged against OSEC funds subject to the usual accounting and auditing rules and regulations. Expenses for the bus rentals, honoraria of speakers and facilitators, training kits, supplies and materials, tokens, and etc. shall be charged against the President's Contingent Funds for FY 2006 given to the National Inter-Agency Task Force.
9. Enclosed are the Kalayaan 2006 program of activities and the Rules and Regulations on the Use of the National Flag (Filipino and English Version).
10. For more information, please contact Ms. Luzviminda F. Dela Rosa and the staff of the Special Events Unit (SEU), 5th Floor, Bonifacio Bldg. DepED Complex, Meralco Avenue, Pasig City with tel. nos. (02) 637-5832/637-5834 or 632-1361 (70) loc. 2211.
11. Immediate dissemination of this Memorandum is desired.

FE A. HIDALGO
Undersecretary
Officer-in-Charge

Encls.: As stated

Reference: DepED Memorandum: No. 164, s. 2005

Allotment: 1—(D.O. 50-97)

To be indicated in the Perpetual Index under the following subjects:

BUREAUS & OFFICES
CELEBRATIONS & FESTIVALS

EMPLOYEES
OFFICIALS

KALAYAAN 2006

108th Anniversary of the Proclamation of Philippines Independence
May 28- June 12, 2006

PROPOSED PROGRAM OF ACTIVITIES

Activities	Day/ Time	Venue	Responsibility Center/s
ARAW NG WATAWAT (Philippine National Flag Day)	May 28 8:00 a.m.	* Rizal National Monument Rizal Park, Manila	NHI/ DepED will be represented by an Undersecretary
	7:00 a.m.	* Battle of Alapan Historical Landmark, Imus, Cavite (IATF to send its official representative)	Mun. of Imus/ Province of Cavite
CONCERT AT THE PARK (In celebration of Flag Day featuring Santos, Ventura, Hocorma Foundation, Inc. Brass Band) G. Isaac F. Cariaga	May 28 6:00 p.m.	Open-air Auditorium Rizal Park, Manila	NPDC For General Public
Peripheral Activities "Watawat Ko, Iwawagayway Ko!" (A Flag in Every Home/ Office/ major thorough fares and Philippines Embassies abroad)	May 28 -June 30	Nationwide	DILG/ NHI/ DPWH/ MMDA City of Manila/ DepED/ DOST/ BSP/ GSP/ DFA
NATIONAL FLAG DAY TARPAULIN EXHIBIT	May 28- June 28	Luzon, Visayas and Mindanao	DepED (6 sets will be given to NL, SL, V, NM, SM, and NCR)
Drama Series on the national heroes to be aired on Radyo Balintataw, Radio DZRH and to mount performances such as poetry reading, telethon interview on our freedom heritage, on NBN Channel 4	May 28- June 12	DZRH/ NBN Channel 4	NCCA/ RTV/ OPS/ PIA For General Public
AGRARYO TRADE FAIR	June 7-11	Department of Agrarian Reform Complex	DAR- Philippine Fruit and Vegetable Industries, Inc. For General Public
PACO PARK PRESENTS "Philippine Folk Songs" (Featuring Chorus Philippines, Joy Nilo- Conductor	June 9 8:00 p.m.	Paco Park, San Marcelino St. Paco, Manila	NPDC For General Public
SINING AT KULTURA (Film showing of the award winning movies such as; "Aishite Imasu, 1941"	June 9 8:00 PM	Open-Air Auditorium, Rizal Park, Manila	NPDC/ NCCA For General Public

"Panaghoy sa Suba"	June 10, 8:00 p.m	Open-Air Auditorium, Rizal Park, Manila	NPDC/ NCCA For General Public
"Walls of Hell"	June 11 8:00 p.m.	Open-Air Auditorium, Rizal Park, Manila	NPDC/ NCCA For General Public
KONSIYERTO MILITAR (Special AFP band and all-female Combo Concert)	June 9 6:00-7:30 p.m. June 10 6:00 a.m.-8:00 p.m. June 12 5:00 p.m.-10:00 p.m.	Open-Air Auditorium, Rizal Park, Manila	For General Public
"SPECIAL TOUR AND WORKSHOP" (A special tour/ lecture for the 17 Regional Education Supervisor II (Social Studies) 17 Regional Education Supervisor (Sibika/ Hekasi) 17 Regional Special Events Unit Coordinators and Education Program Specialists (BEE/BSE-CDD))	June 9-11	North and South Freedom Trail Tour and Workshop in making the Lesson Exemplars	DepED - through Special Events Unit
PILIPINAS, ITO ANG BAYAN KO! (An Independence Day musical presentation featuring the DBP Chorale and DBP Troupe * For final confirmation	June 9	Bulwagan ng Diwang Pilipino	DBP By invitation
BIYAHENG KALAYAAN TOUR 2006 (A one-day guided tour to various historical and cultural places in Intramuros, Manila and nearby Province of Cavite. This will be participated in by underprivileged youth ages 12-17 under DSWD	June 10 7:00 a.m.-5:00 p.m.	Intramuros (Manila) and Aguinaldo Shrine (Kawit)	DSWD By invitation
LIGHTS AND SOUNDS PRESENTATION Martyrdom of Dr. Jose P. Rizal)	9:00 a.m- 5:00 p.m (guided tour) 7:00 p.m.-7:30 p.m. (lights and sound tableau- evening presentation tagalog version	Rizal Park, Manila	NPDC/ PAGCOR For General Public
SPECIAL CONCERT AT THE PARK PRESENTATION (Featuring "ANG LANDAS TUNGO SA KASA- RINLAN, "by the Gantimpala Theatre Foundation	June 11 6:00-7:30 p.m.	Open-Air Auditorium, Rizal Park, Manila	NPDC For General Public
PARADA NG PAG-ANYAYA (A motorcade to be spearheaded by the Fil- Chinse Volunteer Fire Fighters of the Phil.	May 27 and June 11	Metro Manila	Volunteer Fire Fighters Association

"BALIK TANAW SA KASAYSAYAN SA BOOK SALE" (up to 50% discount on selected NHI publicatios)	June 11-12 9:00 a.m.-4:00 p.m.	All NHI operated shrines and museums nationwide and NHI Main Office at the T.M. Kalaw, Ermita. Manila	NHI For Book avid fans
SALINLAHI PRESENTATION (A "Grand Asalto" celebrating the 108th Anniversary of the Proclamation of Philippine Independence presenting a brief capsule history of the Philippines through rich tapestry of music, dance and traditions)	June 11 8:30 p.m.	Tanghalang Nicanor Abelardo, CCP	DOT For General Public
KALAYAAN 2006 ART EXHIBIT (A visual arts exhibit by the Arts Association of the Philippines (AAP))	June 12-30	Kanlungan ng Sining, Rizal Park, Manila	NPDC/ AAP/ PAGCOR For Teachers/ Students
KALAYAAN 2006 INDEPENDENCE DAY TARPULIN EXHIBIT	June 12	NHI Building, T.M. Kalaw Street Manila	NHI For Teachers/ Students
ARAW NG KALAYAAN (Flag-raising and wreath-laying rites at the six (6) historical sites and other NHI designated places all-over the country: 1. Rizal National Monument, Rizal Park, Manila 2. Gen. Emilio Aguinaldo, Kawit, Cavite 3. Andres Bonifacio National Monument, Caloocan City 4. Mausoleo de los Veteranos dela Revolucion, Manila North Cemetery 5. Pinaglabanan Memorial Shrine, San Juan, Metro Manila 6. Barasoian Church Historical Landmark, Malolos City Bulacan 7. Cebu City 8. Davao City	June 12 8:00 a.m. 7:00 a.m. 7:00 a.m. 7:00 a.m. 7:00 a.m. 7:00 a.m. 7:00 a.m.	Guest of Honor: *H.E. President Gloria Macapagal-Arroyo *Vice-President Noli de Castro *Chief Justice Artemio Panganiban *DND Sec. Avelino Cruz * Senate President Franklin Drilon * House Speaker Jose de Venecia Jr. *Presidential Assistant for Visayas * Presidential Assistant for Mindanao or DAR Secretary	NHI DepED Representatives Sec. Fe A. Hidalgo Regional Director NCR- will be on-site Regional Director, Reg. IV-A (CALABARZON) Supt. Div. of Caloocan City Supt. Division of Manila Supt. Division of Pasig/ San Juan Regional Director, Region III Regional Director, Region VII Regional Director, Region XI
PARADA SA KALAYAAN (Independence Day Military Parade)	June 12 8:30 a.m.	Quirino Grandstand	CCP/ AFP For DepED participation, 14 Divisions of NCR will send teachers and students
VIN D' HONNEUR (Cocktail reception to be hosted by	June 12	Rizal Park, Manila (tentative)	DOLE Office of the President (OP)

H.E President Gloria Macapagal-Arroyo JOB AND LIVELIHOOD FAIR	June 12	Quirino Grandstand	CCP/ AFP
KABUHAYAN HANDOG PARA SA BAYAN AGRI-AQUA FAIR AND EXHIBIT (Showcasing the export quality product) TECHNO-DEMO ON FOOD PROCESSING PRESENTATION (Featuring the easy learning methods of food processing)	June 10-12 9:00 a.m.- 4:00 p.m.	Rizal Park, Manila (tentative)	Department of Agriculture
Replication of Kalayaan 2006 Activities Nationwide	May 28- June 12	Nationwide	DILG with member agencies

**Kalayaan 2006
NIATF**

**“Alamin ang mga
Alituntunin sa Paggamit
ng Pambansang Watawat”**



**“Alamin ang mga
Alituntunin sa Paggamit
ng Pambansang Watawat”**

DISENYO NG PAMBANSANG WATAWAT

Ang Pambansang Watawat ay bughaw, puti at pula na may walong sinag ng araw na ginintuang dilaw at may tatlong tala na may limang patulis, na pinahahalagahan at ginagalang ng mga tao.

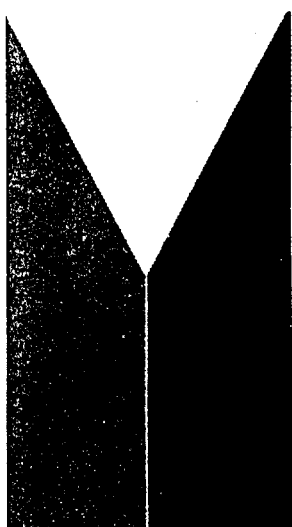

Saan ba dapat iwagayway ang watawat?

LUGAR

- Ito ay dapat iwagayway sa mga pampublikong gusali, liwasan, at sa mga paaralan.

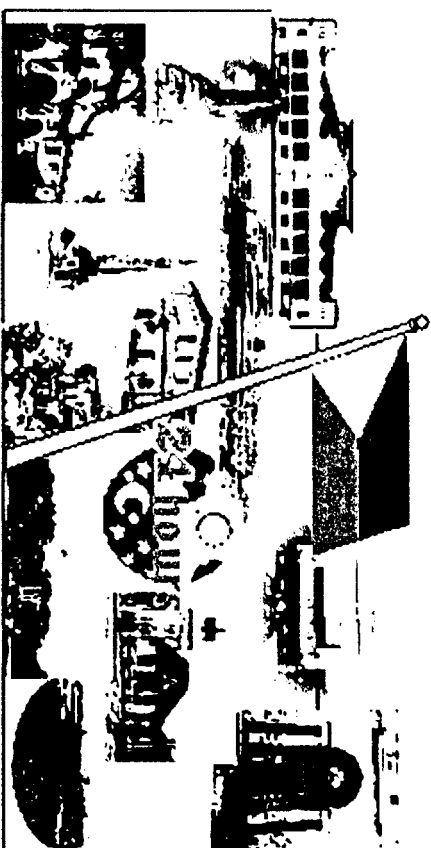

- Ang ating Watawat ay dapat na permanenteng nakawagayway sa tapat ng mga sumusunod na lugar:

> Malakanyang; Senado; Kongreso; Tanggapan ng Kataas-taasan Hukuman; Monumento ni Rizal sa Rizal Park, Maynila; Monumento ni Bonifacio sa Kalookan; Dambanang Emilio Aguinaldo - Kawit, Cavite; Makasaysayang Simbahan ng Barasoain - Malolos, Bulacan; Marcela Agoncillo Historical Landmark - Taal, Batangas; Libingan ng mga di kilalang sundalo; Libingan ng mga Bayani, Taguig, Metro Manila; Mausoleo ng mga Beterano ng Rebolusyon - North Cemetery, Manila; Lahat ng Pandaigdigang Daungan; At lahat ng mga lugar na hihirangin ng National Historical Institute

- Ang lahat ng sangay ng pamahalaan ay kinakailangang magbigay galang sa mga araw ng watawat na may karampatang seremonya. Ang sosyo-siblikong grupo, non-government organizations at mga pribadong sektor ay inaanyayahang obserbahan at makipagtulungan sa matagumpay na pagdiriwang.
- Ang watawat ay maaring itanghal sa mga sumusunod:
 - a. Sa loob at labas ng mga gusali; permanente man o tanggalin na tagdan. Kapag ito'y itinanghal sa loob ng gusali dapat palagi itong nasa kaliwang bahagi.
 - b. Iladlad ito sa pinakaprominenteng parte ng isang lugar o gusali.
- Ang lahat ng tanggapan ng pamahalaan, kabiliang na ang pambansa at lokal na yunit at institusyon ay kinakailangang sumunod sa pagtataas ng watawat na ginaganap tuwing Lunes ng umaga at ng seremonya sa igbaba nito tuwing biyernes ng hapon.
- Kabilang din rito ang mga pribadong tanggapan at paaralan.

Mga Sasakyang Pandagat

- Ang watawat ay kailangang iwagayway sa mga sasakyang pandagat at mga pabor na pangkalakal na nakarehistro sa Pilipinas na may bigat na higit sa 1,000 tonelada.
- Kailangang iwagayway ang watawat sa mga militar, civil o anumang sasakyan ng pamahalaan.
- Sa mga sasakyang pandagat na nakarehistro sa Pilipinas, ang watawat ay dapat iladlad sa likuran nito habang ito'y nakadaong.



Panghimpapawid

- Sa lahat ng mga sasakyang panghimpapawid na nakarehistro sa Pilipinas, ang Pambansang Watawat ay kailangang prominenteng nakatanghal na pahalang mula sa "fuselage" (sa harapan o malapit sa nguso ng eroplano) nito.

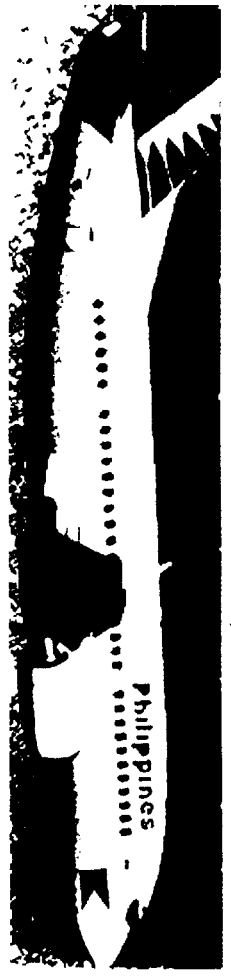

Kailan dapat iwagayway ang watawat?

Ang watawat ay kailangang inilawan sa gabi ay maari ding iladlad ito sa mga pribadong gusali at tahanan tuwing:



- > Abril 9 (Araw ng Kagitingan);
- > Mayo 1 (Araw ng Manggagawa)
- > Mayo 28 (Pambansang Araw ng Watawat) hanggang Hunyo 30 (Araw ng Kalayaan);
- > Huling Linggo ng Agosto (Araw ng mga Bayani);
- > Nobyembre 30 (Araw ni Bonifacio);
- > Disyembre 30 (Araw ni Rizal);
- > at ibang pang mga araw na idineklara at pinasinayaan ng Pangulo at/o ng mga local na pinuno ng pamahalaan.

- Ang Pambansang Watawat ay itaas at itanghal simula sa umaga at ibaba pagdating ng dapit hapon sa loob ng isang taon sa mga flagstaff sa harap ng pampubliko at pribadong gusali.

- Sa panahon ng kapayapaan, dapat iwagayway ang bandila sa tagdan na nasa itaas ang asul at sa panahon ng digmaan, pula ang dapat nasa itaas. Kung ito naman ay nakasabit nang patayo, ang kulay asul ay dapat nasa kaliwa (mula sa kinatayuan ng tumitingin) sa panahon ng kapayapaan at nasa kanan ang asul sa panahon ng digmaan.

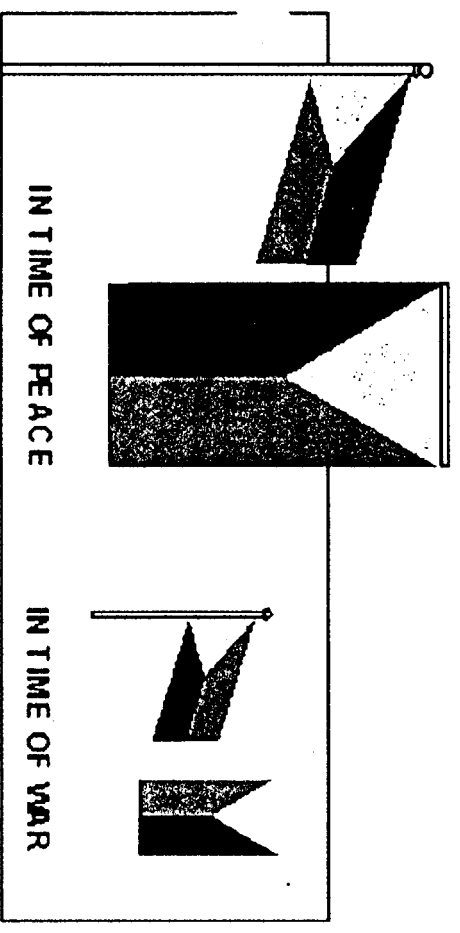

- Ang watawat ay dapat iwagayway sa kalahating sukat ng tagdan (half mast) bilang tanda ng paggalang at pagdadalamhati sa mga namatay na sumusunod na opisyal:

- ang pangulo o ang dating pangulo - sampung (10) araw;
- ang pangalawang pangulo, pinuno ng kataas-taasang hukuman, ang pangulo ng senado at taga-pagsalita ng mababang kapulungan - pitong (7) araw;
- mga kalihim ng gabinete, katulong ng mahistrado ng Korte Suprema, mga miyembro ng Senado at Mababang Kapulungan, Chief of Staff ng Armed Forces of the Philippines, at Director-General ng Philippine National Police o katumbas na ranggo - limang (5) araw;
- mga pinuno ng pambansang ahensya, kabilang ang GOCCs (government owned and controlled corporations) at GFIs (government financial institutions) o katumbas na ranggo - tatlong (3) araw;
- ang Commanding Generals ng Philippine Air Force, Philippine Army at Flag Officer in Command ng Philippine Navy o katumbas na ranggo - tatlong (3) araw;

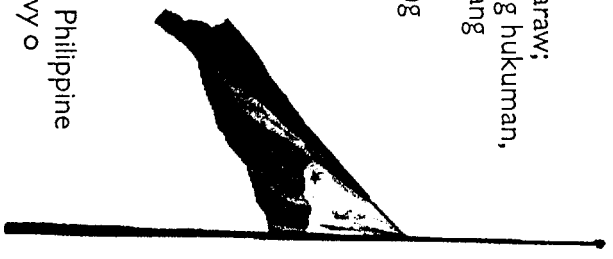

- governador, bise-governador, alkalde ng lungsod at munisipal, bise-alkalde ng mga lungsod at munisipal - tatlong (3) araw;
- miyembro ng Sangguniang Panlalawigan, Sangguniang Panglungsod, at Sangguniang Bayan, sa araw ng libing;
- beterano ng nakaraang digmaan, kapitan ng barangay at mga kagawad sa araw ng libing;
- dating pambansa at lokal na opisyal ng pamahalaan, hinirang o ibinoto, maliban doon sa mga nabanggit sa araw ng paglilibing sa loob ng kaniyang dating pinamumunuan - sa pamamagitan ng resolusyon ng kani-kaniyang Sanggunian;
- regional director, superintendent, supervisors, principals, mga guro at iba pang opisyal ng paaralan, sa araw ng paglilibing at sa pamamagitan ng utos ng karapatang awtoridad ng paaralan;
- ang mga tumanggap ng patakaran at deklarasyon, sa araw ng libing at sa pamamagitan ng utos ng pangulo o ng kongreso; at
- ibang tao na hinirang ng National Historical Institute kabilang ang dating bise-presidente, pinuno ng kataas-taasang hukuman, pangulo ng senado at taga-pagsalita ng mababang kapulungan - pitong (7) araw.

Sa mga letrang "c" hanggang "e", ang watawat ay dapat iwagayway sa kalahati ng tagdan (half mast) sa harap ng gusali na kung saan namamasukan ang namatay na opisyal, at sa letrang "f" hanggang "h" sa pamamagitan ng Resolusyon ng Sanggunian o sa utos ng lokal na pinunong ehekutibo.

Bago ilagay sa half mast, kailangan itaas muna ang watawat hanggang tuktok at saka lamang ibaba, ilagay sa half mast. At bago ibaba ito, kailangan muling itaas hanggang dulo bago ito ibaba.

Ang watawat ay dapat iwagayway sa half mast tuwing anibersaryo ng kamatayan ng ating mga bayani, kalamidad, o anumang malubhang pangyayari.

Ang watawat ay dapat permanenteng naka half mast, araw at gabi, sa puntod

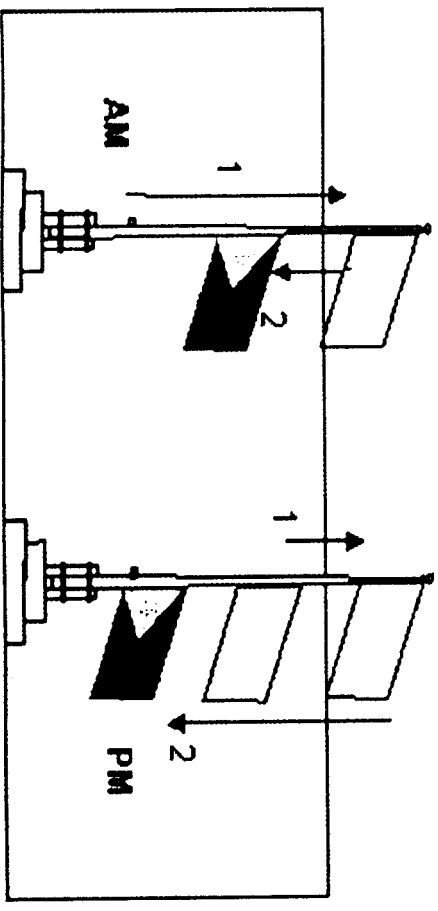

ng di-kiilalang sundalo, Libingan ng mga Bayani, Fort Bonifacio, Taguig, Metro Manila; Mausoleo de los Veteranos de la Revolución, North Cemetery, Manila; at sa lahat ng mga sementeryong nakalaan sa mga beterano. Ang watawat sa mga nabanggit na lugar ay dapat may wastong ilaw kung gabi.

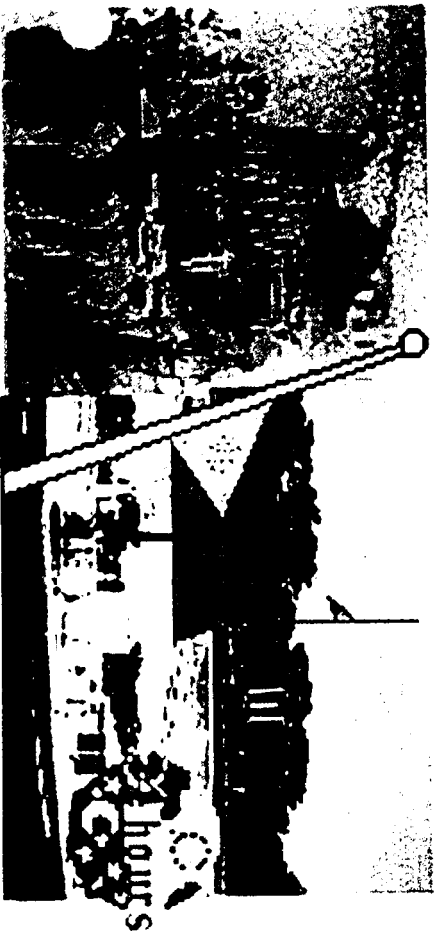

Kabaong (Casket)

Ang watawat ay maaring ipatong sa kabaong ng mga pinarangalang tao mula sa military, beterano ng nakaraang digmaan, national artists, at mga sibilyan na may ginawang kinikilalang paglilingkod sa bayan, na maaring pagpasyahan ng naukol sa lokal na pamahalaan. Sa mga ganitong pagkakataon, ang watawat ay nararapat na ilagay sa kung saan ang puting tatsulok ay nasa ulo

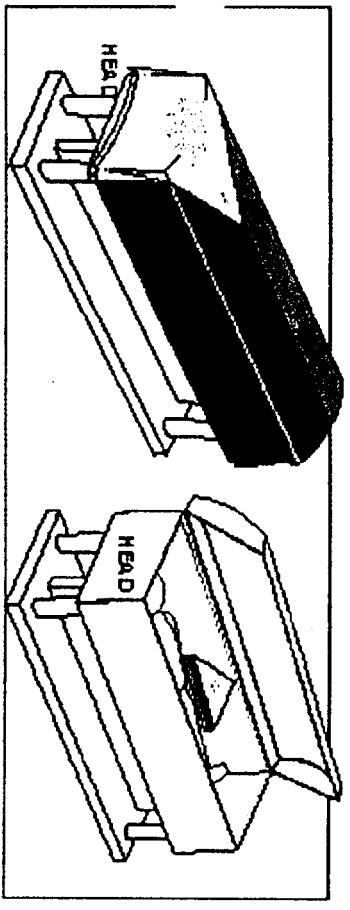

at ang asul ay dapat ipatong sa kanang bahagi ng kabaong. Ang watawat ay hindi dapat isama sa hukay o hayaang dumait sa lupa. Magaling itong itupi at ibigay sa mga namatayan o sa malapit na kamag-anak.

Kung nakabukas ang kabaong, itupi at ipatong ang bandila dito.

Hindi dapat maglagay ng anumang bagay sa ibabaw ng watawat, rialiban sa mga bagay na panrelihiyon na nangangahulugang "Diyos bago Bansa."

Pano dapat ilagay ang watawat?

- Ang watawat ay kailangang masilang itaas at ibaba ng may pagpipitagan watawat.
- Itali na muna ito sa lubid ng maayos habang hinhintay ang pagtaas ng watawat.
- Huwag pasasayarin ang watawat sa lupa, o sa anumang bagay.
- Pagkatapos malbaba, ang watawat ay kinakailangang ingatan at tiklupin ng maayos bilang bahagi ng seremonya.
- Ang pagsasagawa ng pagpupugay sa watawat ay kailangan simple at marangal.
- Tuwing may seremonya ng pagtataas sa watawat, ang kapulungan ay dapat tumayo na nakaharap sa watawat. Sa oras na tumugtog ang pambansang awit, lahat ay kinakailangan tumayo ng tuwid, ang mga sasakyan ay dapat ding nakahinto.
- Dapat ilagay ng mga tao ang kanilang palad sa dibdib, at yung mga nakasombbrero ay dapat tanggalin. Kailangang sumaludo ang mga militar, iskawts, at security guard.
- Dapat ding tumayo nang tuwid, ilagay ang palad sa dibdib kapag dumaraan ang watawat tuwing may parada.
- Ang tagdan ay kailangang nasa prominenteng lugar kung saan matayog at kitang Kita ang watawat sa kapaligiran. Ang tagdan ay di dapat na kasing taas o higit pa sa tagdan ng Tagdan ng Kalayaan (107 ft.) na nasa Rizal Park, Manila.

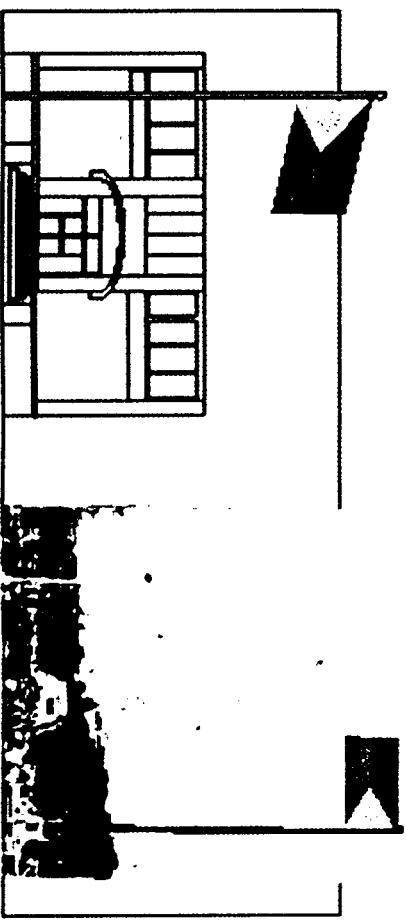

- Dapat ituwid ang tagdan na nakabaon sa lapa at patulis sa itaas. Ang pinakamaikling haba ng Pambansang Watawat ay isangkapat na bahagi (1/4) ang taas mula sa tagdan samantala ang pinakamahabang bahagi nito ay 'sang-katlong (1/3) taas ng tagdan.

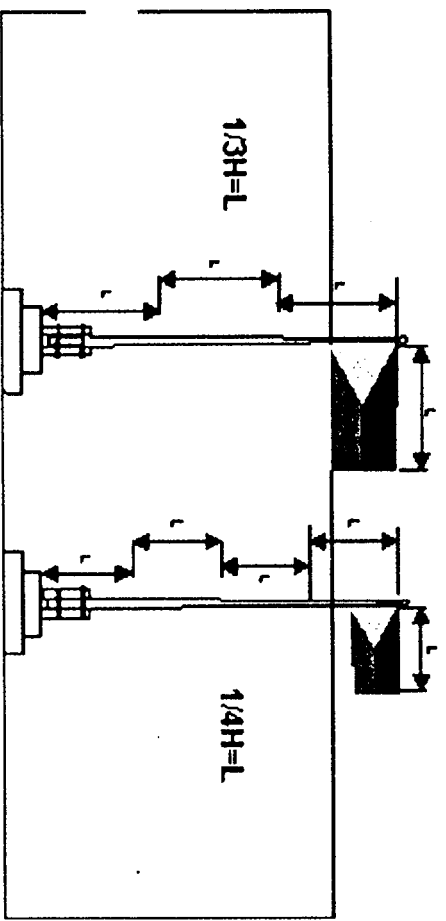

- Kapag ang ating watawat ay mayroong kasamang watawat ng ibang bansa, ang mga watawat ay dapat na singsukat at nakaladlad sa mga tagdan na magisntaas. Ang watawat natin ang unang itinataas at huling ibinababa.

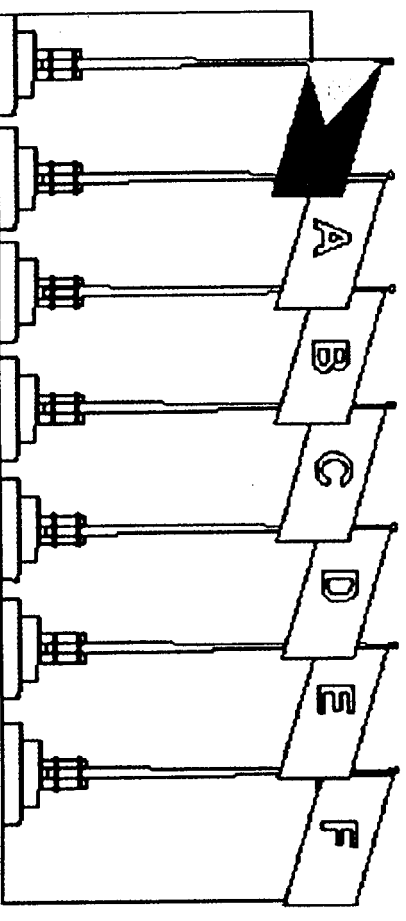

- Kapag itinanghal sa semicircle ang mga danila ng idang unais k isama ang ating watawat, dapat itong nakapagitra; nasa harapan ng lagusan; o sa tapat ng monumento. Isaayos ang mga bandila ayon sa alfabeto, counter clockwise.

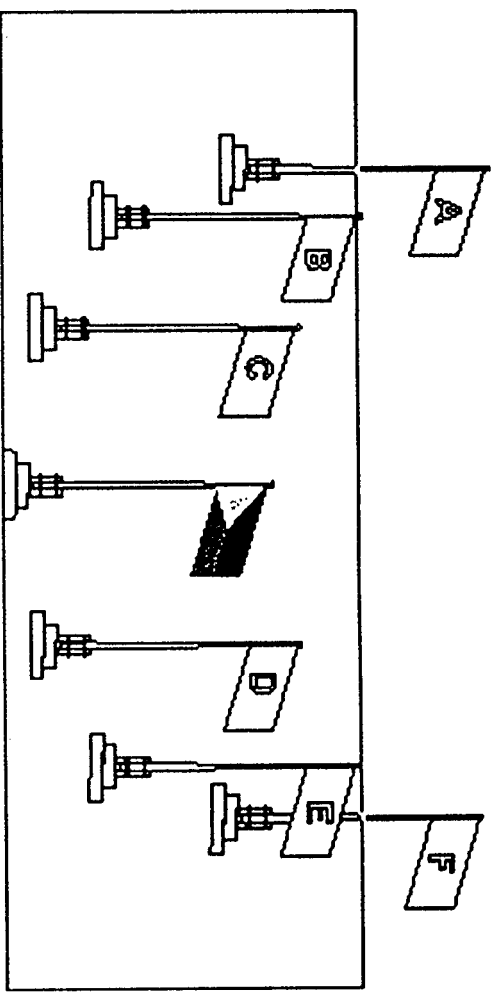

- Kapag naka-hilera sa isang parada ang mga watawat ng ibang bansa, ang ating watawat ay dapat nasa pinaka kaliwang dako (mula sa posisyon ng tumitingin). Isaayos ang mga watawat, alfabeto mula kaliwa pakanan.

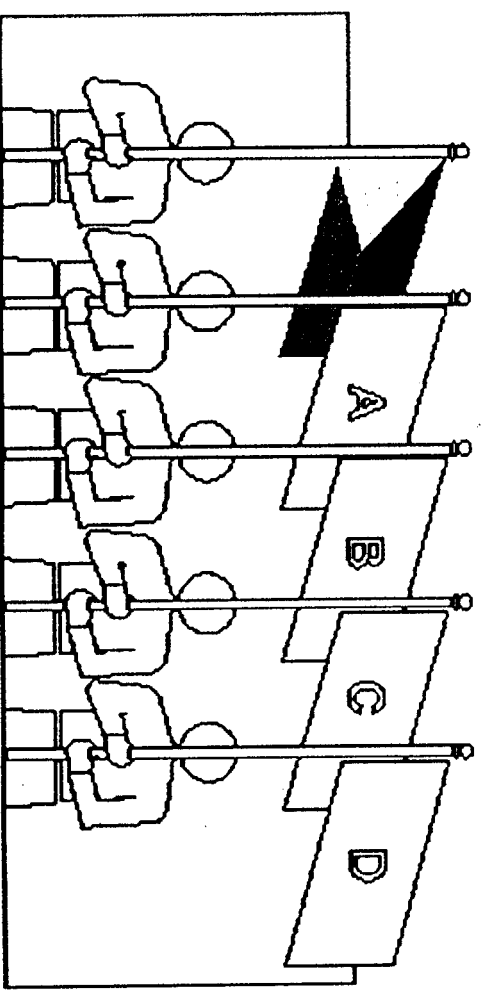

• Kapag tumutunog ang mga watawat, ng ibang panig, dapat isaad giuda at bigat aking bandila o di kaya'y dapat itong nasa kaliwang bahagi (mula sa posisyon ng tumitingin). Isaayos ang ibang watawat ayon sa alfabeto.

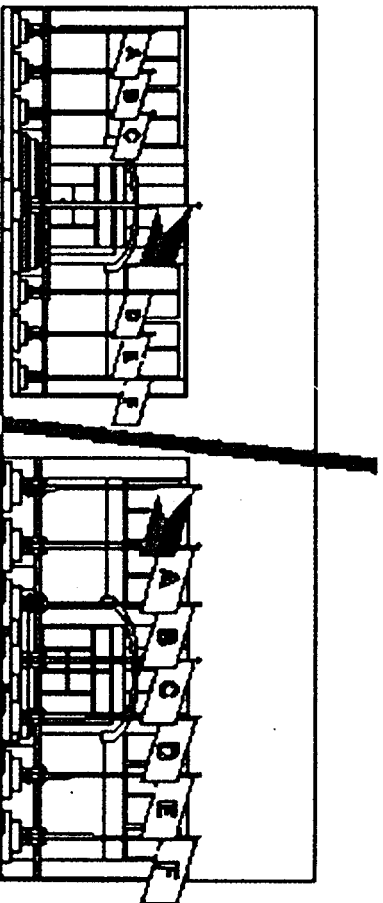

• Kung may espesyal na okasyon, at iisa lamang ang sasabitan ng mga watawat; ang house flag* ay maari ring iwagayway kasama ang pambansang watawat subalit dapat itong nakapalalim at di dapat na mas malaki sa pambansang watawat.



• Huwag itatapon ang luma o sirang watawat. Sunugin ito at ibaon ang abo sa lupa. Kaagad palitan ang watawat sa oras na makita na may sirang o pagkaluma ito.



* House Flag – mga watawat/bandila ng iba't ibang asosasyon, kagawaran/paaralan atbp.

• Kapag nakitang naiatali ang bandila, ito'y naghuhudyat na may panganib o mayroong nangangailangan ng tulong.

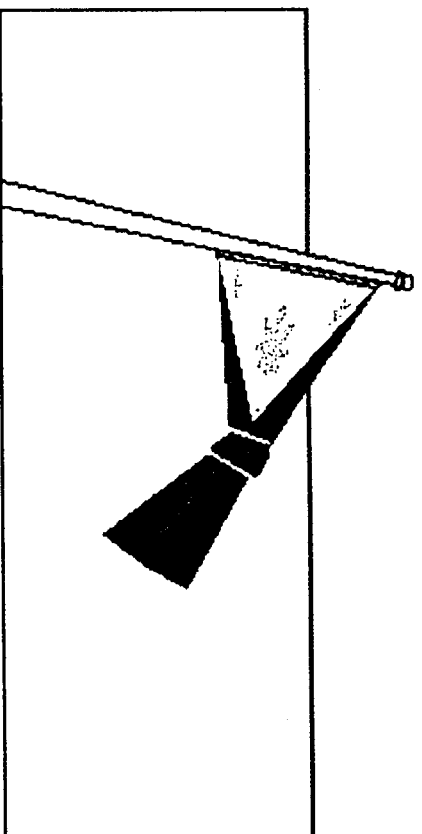

Panunumpa sa Pambansang Watawat

Ang mga sumusunod ang siyang dapat na Panunumpa ng Katapatan sa Pambansang Watawat.

Ako ay Pilipino.
 Buong katapatang nanunumpa
 Sa Watawat ng Pilipinas
 At sa bansang kanyang sinasagisag
 Na may dangal, katarungan at kalayaan
 Na pinakikilos ng sambayanang
 Maka-Diyos,
 Maka-tao,
 Makakalikasan, at
 Makabansa

Ang panunumpa ay dapat na bigkasin pagkatapos ng pag-awit ng pambansang awit. Dapat naka bukas ang kanang kamay habang sinasabi ang panunumpa. Sa mga taong walang relihiyon o may ibang paninindigang pinagbabawalan na magsambit ng panunumpa ay dapat magpakita ng paggalang sa pamamagitan ng pagtayo ng tuwid.

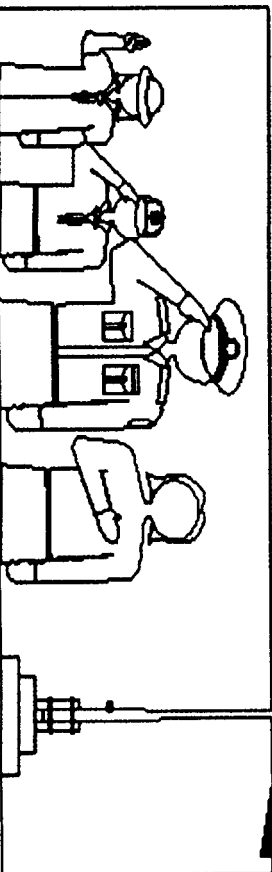

- 2. panakip sa kisame, dingding, istatwa, o ibang bagay;
- 3. bilang banderita sa hood, gilid, likod, at ibabaw ng sasakyan;

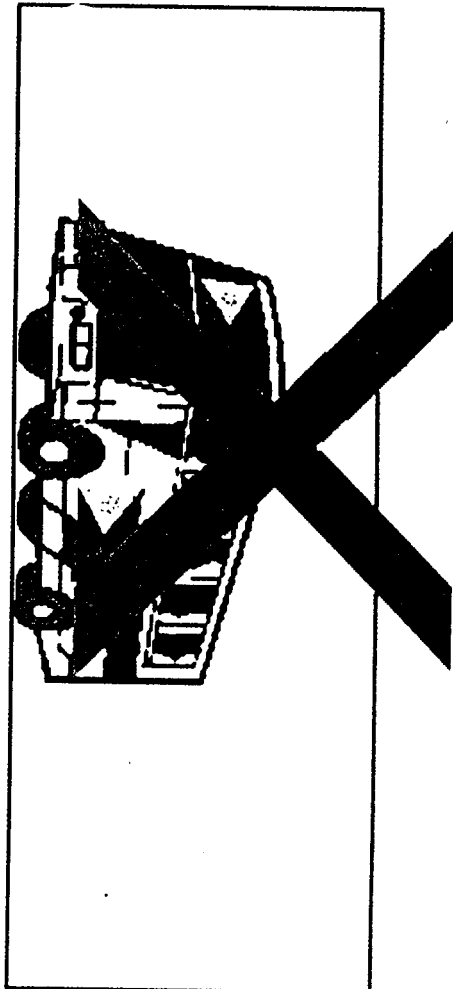

- 4. bilang panghataw o pamalo; at
- 5. bilang panungkit

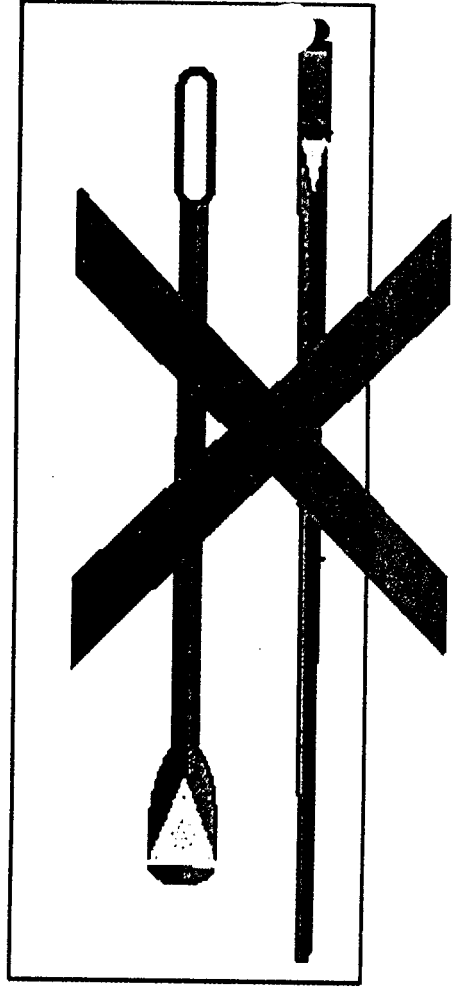

c. bawal din ang paggamit sa watawat:

- 1. sa ibaba ng kahit na anong kuwadro o larawan;

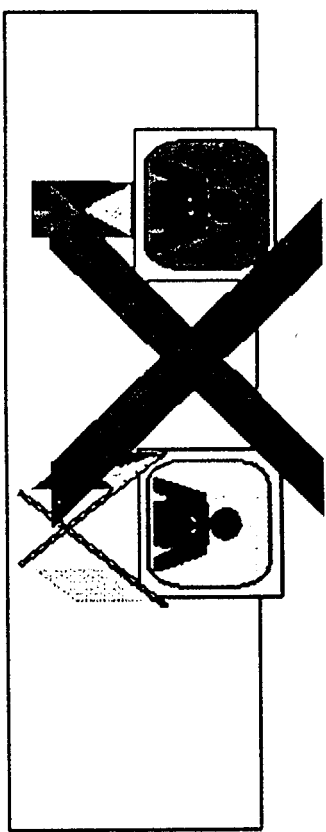

- 2. ilagay na pahiga; dapat itong iwagayway sa itaas;

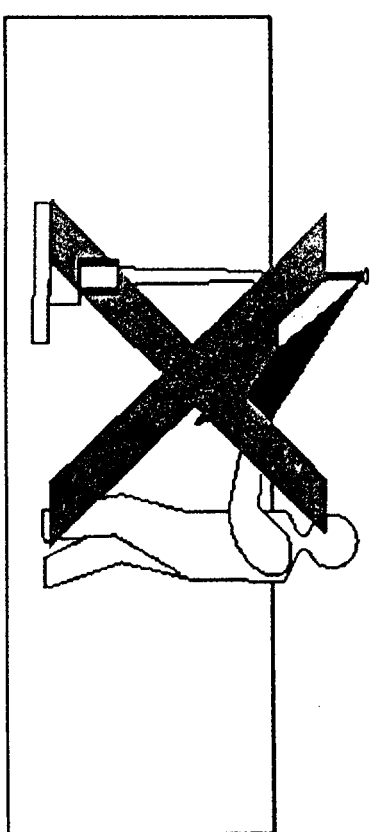

- 3. sa ibaba ng kahit anong plataporma; at

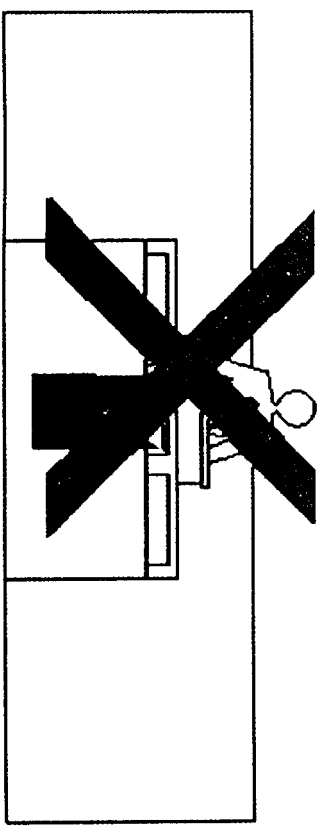

4. Sa sayawan, sabungang, mga clubs, casinos, sugalan, at lugar ng mga bisyo.

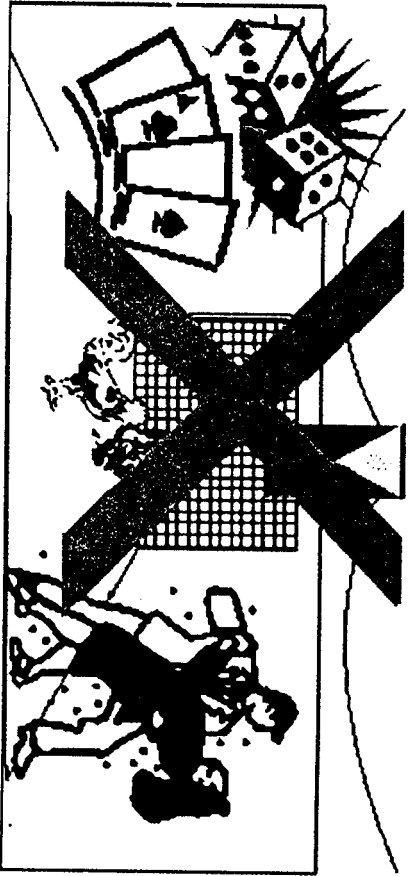

d. Bilang damit o bahagi ng kasuotan o uniporme.

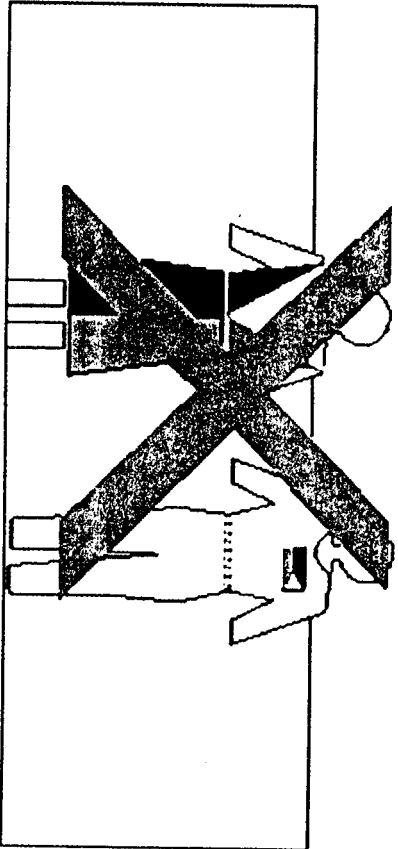

e. Sulatan, drowingang, pinturahan, markahan, o anumang panunulat sa watawat.



f. Gawing bahagi ng disenyo sa punda, panyo o anumang paninda.

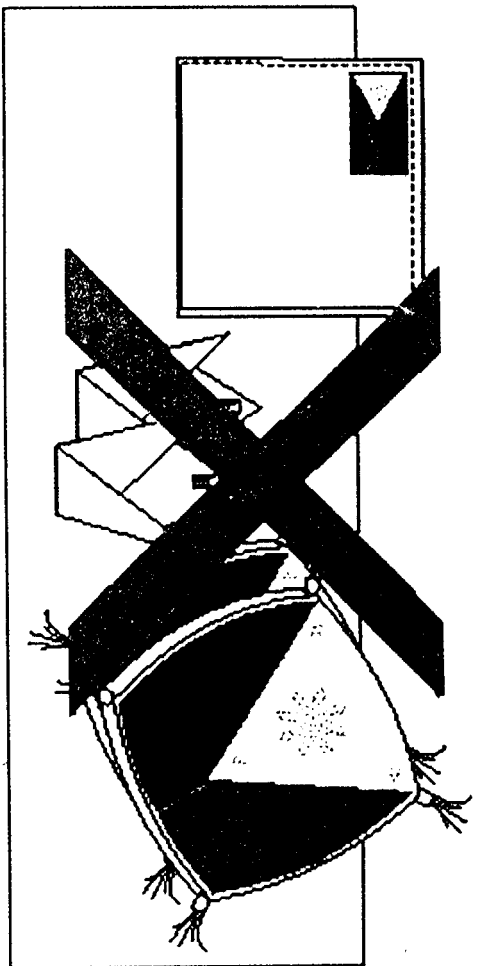

g. Ang pagtatanghal sa publiko ng kahit anong banyagang watawat maliban sa embahada nito at iba pang diplomatikong establisimiyento at sa mga tanggapan ng mga internasyonal na organisasyon.

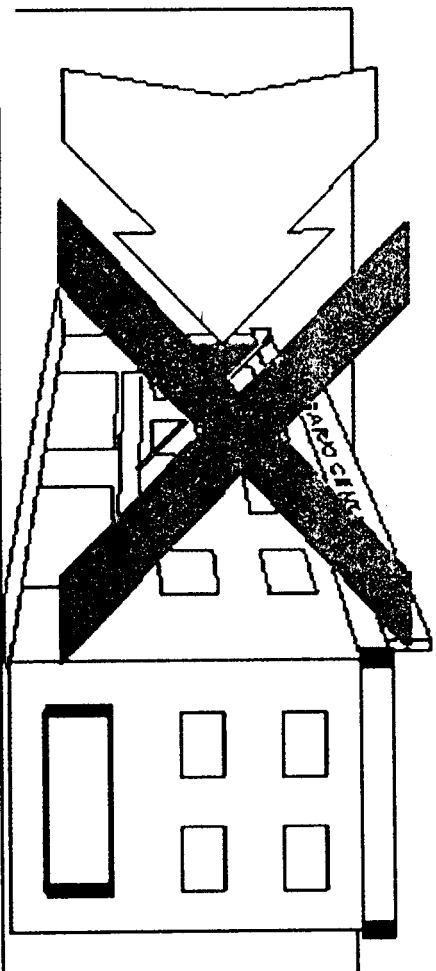

h. Gamitin ito o maging bahagi ng kahit anong anunsyo o informerrial; at

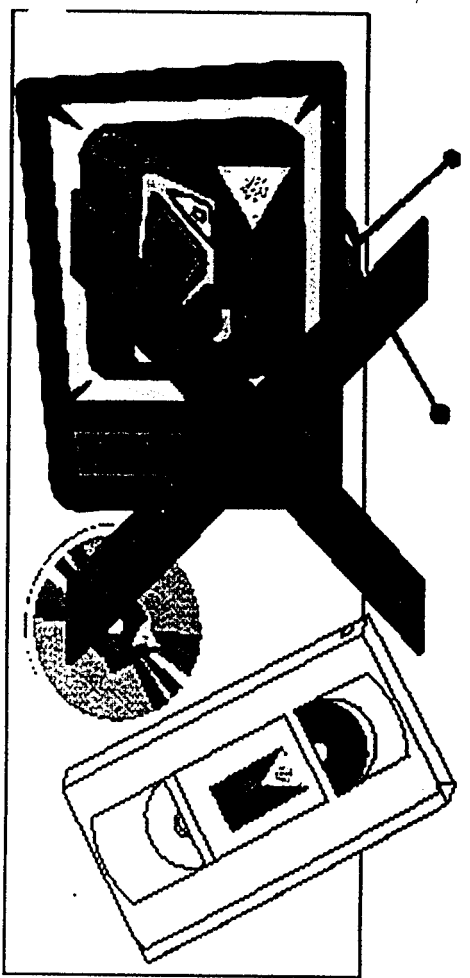

i. Tanghal ang Pambarang Watawat sa harap ng gusali o mga tanggapang Inookupa ng mga banyaga.

Para sa karagdagang tanong, reklamo, at iba pa ukol sa paggalang sa watawat tumawag sa mga sumusunod:

HOTLINES ON FLAG ADVOCACY:

- **NHI** : 523-1037 / 523-9050;
523-9043
- **MMD** : 882-4150
- **BOY SCOUTS** : 527-5112 or 527-8317 to
20 loc.225
- **GIRL SCOUTS** : 526-5193
- **KNIGHTS OF RIZAL** : 528-1974 / 521-0141;
0927-448-1115 c/o
Ruby Gonzales
- **DER.PED** : 637-5832-34 c/o
Luz dela Rosa
- **DPWH** : 527-9727 / 527-2647
- **DOT** : 525-4611
- **PIA** : 920-4652 / 920-4346

PIA - Planning and communication Research Division with National Historical Institute

Know the Rules and Regulations on the Use of the National Flag

No. of pages - 9

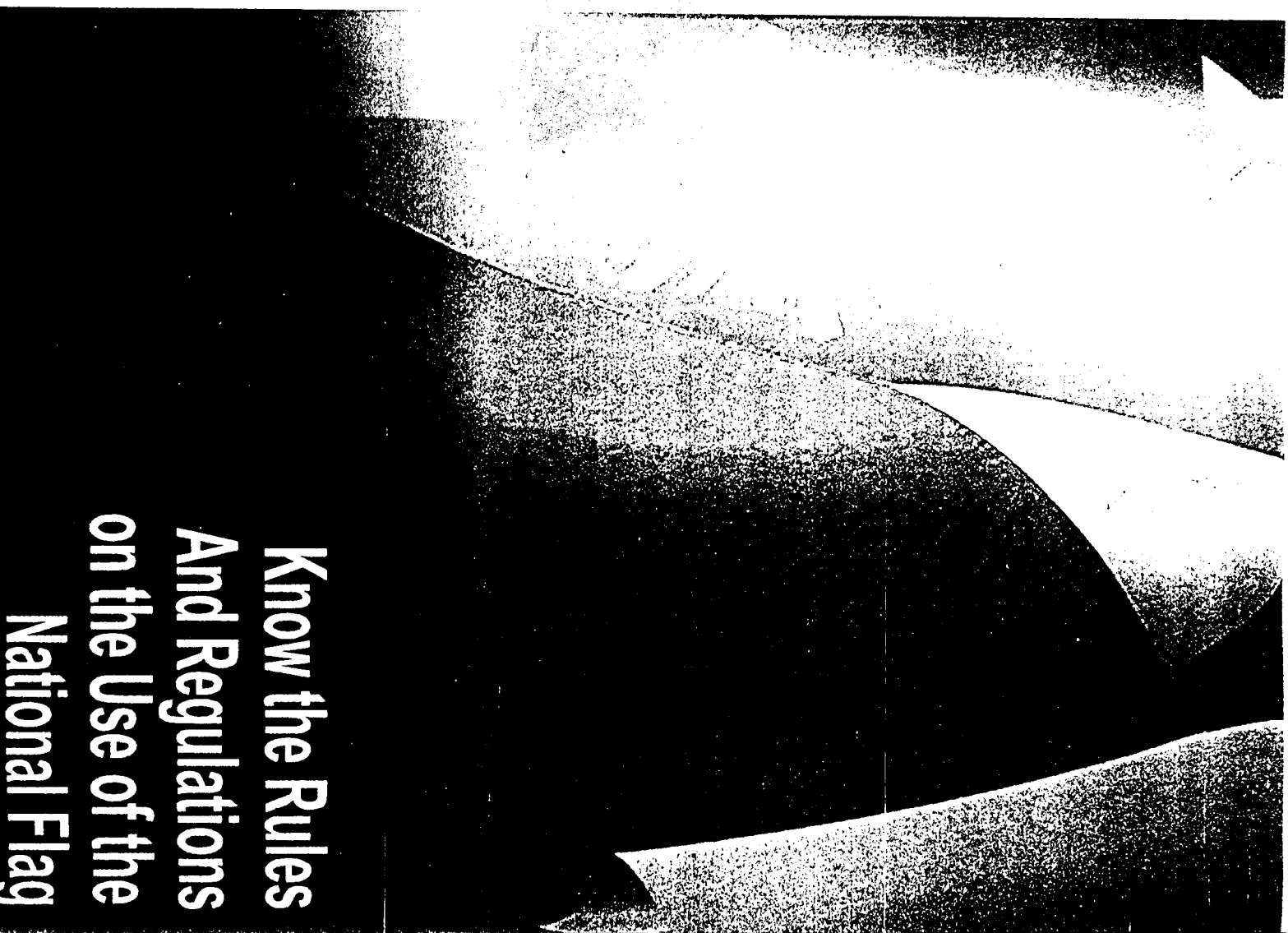

**Know the Rules
And Regulations
on the Use of the
National Flag**

**Rules and Regulations Implementing Republic Act No. 8491,
series of 1998
The Code of the National Flag, Anthem, Motto, Coat-of-Arms
And Other Heraldic Items and Devices in the Philippines**

What is R.A. 8491?

It is the Flag and Heraldic Code of the Philippines, which promotes or sustains reverence and respect for the Filipino flag, the national anthem and other national symbol, which embody national ideals and traditions.

What is the scope of application of R.A. 8491?

The coverage of R.A. 8491 applies to individuals, public and private entities, military and police agencies, and other branches and instrumentalities of the national and local government including government owned and/ or controlled corporation and shall be observed in and within the entire territory of the Philippines.

Who is the implementing agency?

The National Historical Institute shall be the agency tasked to implement rules of R.A. 8491 or the code of National Flag, Anthem, Motto and Coat-of-Arms and other Heraldic Items and devices of the Philippines.

The NHI shall perform planning, monitoring, coordinating, implementing, and policy-formulating functions, wherever and whenever possible, and in the process exercise administrative, regulatory and supervisory authority over the implementation of R.A. 8491.

Definition of terms

- a. "Military" shall mean all branches of the Armed Forces of the Philippines including the Philippine National Police, the Bureau of Jail Management and Penology, and the Bureau of Fire Protection;
- b. "Festoon" shall mean to hang in a curved shape between two points as in a decoration;
- c. "National Flag" shall mean the National Flag and Ensign of the Philippines as expressed and provided in the Constitution of the Philippines, R.A. 8491;
- d. "Fly" shall mean the part of the flag outside the hoist or length;
- e. "Hoist" shall mean the sleeve or heading; part of the flag nearest the staff or the canvass to which the halyard is attached;
- f. "Symbol" shall mean any conventional sign which reveals man's achievement and heroism, identification of authority and a sign of dignity;

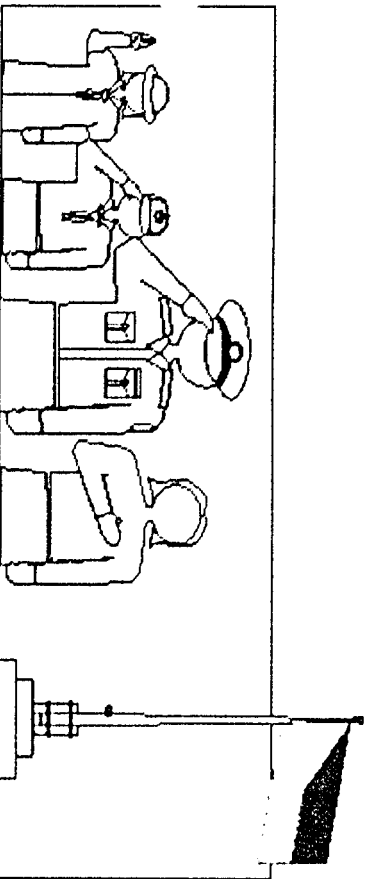

- g. "Half-mast" shall mean lowering the flag to one-half the distance between the top and bottom of the pole;
- h. "Halyard" shall mean the long rope where the flag fastens and which runs up the length of the flagpole;
- i. "Inclement weather" shall mean that a typhoon signal is raised in the locality or during heavy downpour in the area;
- j. "National Anthem" shall mean the Lupang Hinirang, the Philippine National anthem;
- k. "Official Residences" shall mean Malacañang, and other government-owned structure where the president resides, and other structures occupied by the Philippine consulate or embassies abroad;
- l. "Places of Frivolity" shall mean places of hilarity marked by or providing boisterous merriment or recreation;
- m. "Advertisement or Infomercial" shall mean advertisement or any information material in print, radio, television, cinema, video and the like, outdoor and electronic media, seeking to promote individuals, entities, products or services for commercial, political purposes or information campaigns;
- n. "Heraldic Items and Devices" shall mean coat-of-arms, seals, logos insignia, badges, flashes, patches, orders and decorations, medals, stars, citations, lapel pins, trophies, dry, wax or wet seals, and imprints on letterheads, envelopes and cards;
- o. "Government Entities" shall mean all branches of the government, its bureaus and attached agencies, constitutional offices, local government offices, government-owned and/or controlled corporations, government financial institutions, state universities and colleges, Armed Forces of the Philippines, including its basic component units; and;
- p. "Vexillary Items" shall mean national, local house flags or administrative, institution, corporate, unit and other organizations banners.

The National Flag has three colors, blue, white and red with eight-rays and golden yellow sun, and three stars, which are five-pointed, consecrated and honored by the Filipino people.

Where and when do you raise and display the Filipino flag?

- It shall be displayed in:
 - ✓ public buildings;
 - ✓ official residences;
 - ✓ public plazas;
 - ✓ public schools and learning institutions;
 - ✓ naval vessels;
 - ✓ merchant ships of Philippine registry;
 - ✓ military, civil or state vessel;
 - ✓ pleasure, merchant, fishing boats or yachts;
 - ✓ on board vessels of Philippine registry; and
 - ✓ on the aircraft of Philippine registry.



- It shall be permanently hoisted day and night in front of the following:

- ✓ Malacañang Palace;
- ✓ Congress of the Philippines building;
- ✓ Supreme Court building;
- ✓ Rizal Monument in Luneta, Manila;

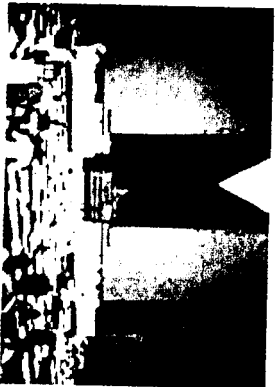

- ✓ Bonifacio Monument in Kalookan City;
- ✓ Emilio Aguinaldo Shrine in Kawit, Cavite;
- ✓ Barasoain Church Historical Landmark in Taal, Batangas;
- ✓ Tomb of the Unknown Soldier;
- ✓ Libingan ng mga Bayani, Taguig City;
- ✓ Mausoleo de los Veteranos de la Revolucion, North Cemetery, Manila;
- ✓ All International ports of entry; and
- ✓ All other places as may be designated by the Institute.

The National Flag in these sites shall be properly illuminated at night.

- It shall be displayed in private buildings/residences or raised in the open flag-staffs of said building every:
 - ✓ April 9 *Araw ng Kagitingan*
 - ✓ May 1 *Labor Day*
 - ✓ May 28 to June 30 *National Flag Day*
 - ✓ June 12 *Independence Day*
 - ✓ Last Saturday of August *National Heroes Day*
 - ✓ November 30 *Bonifacio Day*
 - ✓ December 30 *Rizal Day*

- ✓ On such other days as may be declared or approved by the President and/or local chief executives.

- The National Flag may be raised and displayed at sunrise and lowered at sunset throughout the year.

- If flown from a flagpole
 - ✓ the blue field should be on top in time of peace while
 - ✓ the red field on top in time of war.

- If in a hanging position



- ✓ the blue field should be to the left of the observer's point of view in time of peace and the
- ✓ red field should be to the left in time of war.

- If the flagpole is planted on the ground,
 - ✓ it should be on a prominent place
 - ✓ not be of equal height or higher than the Independence Flagpole at Rizal Park, Manila
 - ✓ straight and slightly tapering at the top.

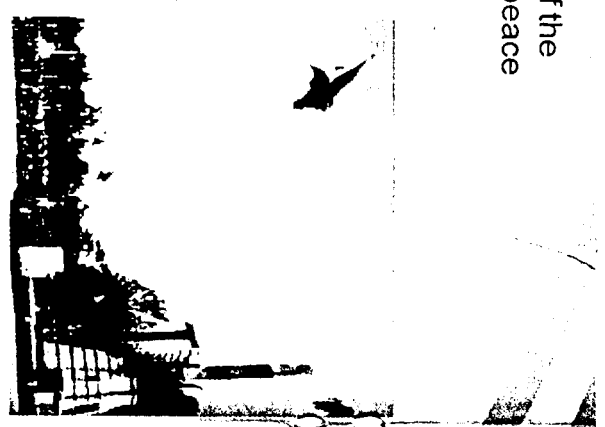

- Height**
- The minimum length of the National Flag is one-fourth the height of the flagpole.
 - The maximum length of the National Flag is one-third the height of the flagpole.

Placing of flag

- When the National Flag is flown with flags of other countries the flags must be
 - ✓ of equal size
 - ✓ on separate staffs
 - ✓ of the same height
 - ✓ the National Flag should be raised first and lowered last.

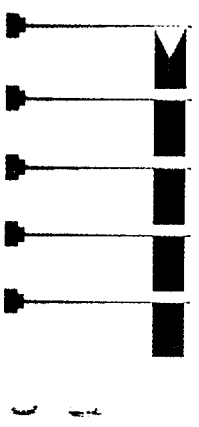

- When displayed in a semi-circle, the National Flag should be at the center.
- When displayed in a circle of house flags or flags of other countries, the National Flag shall face

- ✓ the main road (point of reference km 0 Rizal Park, Manila);
- ✓ in front of a monument
- ✓ main entrance of the building
- ✓ flags of other countries or house flags should be arranged
 - counter clockwise,
 - alphabetically, and
 - by precedence or by protocol.

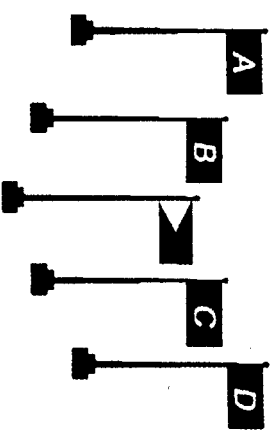

- When displayed in a row or in a parade with flags of other countries, the National Flag shall be
 - ✓ on the left (observer's point of view) of the other flags;

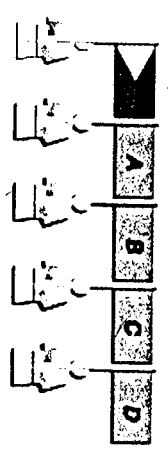

- flags of other countries shall be arranged in alphabetical order from left to right, by precedence, or by protocol

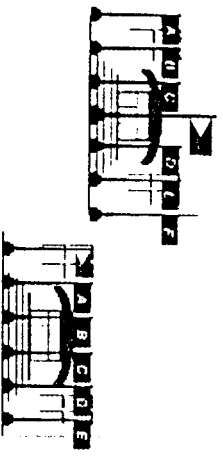

- When in a parade of house flags the National Flag shall be
 - ✓ at the center of the line
 - ✓ arranged in alphabetical order or by protocol from left to right (of the observer's point of view).
- During special occasions, if there is only one flagpole
 - ✓ the house flag may be flown at the same halyard with the National Flag
 - ✓ the house flag should not be bigger than the National Flag

- The National Flag should not be raised when the weather is inclement.
 - ✓ when the flag is torn or worn out;
 - ✓ the National Flag should be solemnly burned to avoid misuse and desecration;

- ✓ the National Flag should be replaced immediately when it begins to show signs of wear and tear.

The National Flag may be displayed

- ✓ inside the building (placed at the left of the observer if one enters the room);
- ✓ outside the building;
- ✓ on stationary or movable flagpole;
- ✓ from the top of the flagpole;
- ✓ from a staff projecting upward from
 - the window sill,
 - roof,
 - canopy,
 - balcony or,
 - facade of a building;
- ✓ in a suspended position;
- ✓ flat against the wall;
- ✓ hanging vertically in the middle of a two-way traffic
- ✓ The blue field should be pointing east if the road is heading south or north
- ✓ If the road is heading east or west, the blue field should be pointing north

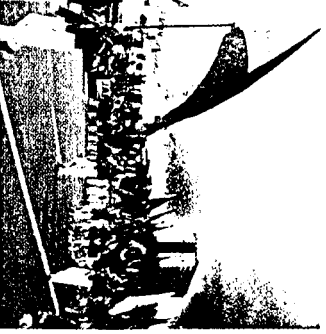
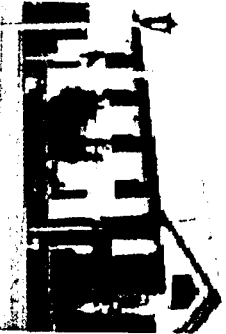

- hanging vertically at the sides or middle of a one-way traffic road
 - ✓ The blue field should be at the left of the observer;
- the National Flag should be raised briskly and lowered ceremoniously;

- it should be properly folded before hanging for the start of the ceremony;
- it should not be left hanging at the base of the flagpole while waiting for the flag ceremony; and
- it should never touch anything beneath it.

Conduct of Flag Raising and Lowering Ceremonies

- Every Monday morning and Friday afternoon institutions must observe flag ceremony including:
 - Local government offices
 - National government offices
 - Private establishments (with flag in their compound)
 - Primary and secondary schools
 - Other learning institutions
- Everyone must act properly upon hearing the National Anthem or when the flag is passing in parade:
 - vehicles shall stop
 - persons present must
 - ✓ put their palms over their chest
 - ✓ remove their hats
 - the following must salute
 - ✓ security guards
 - ✓ military in uniforms
- During the lowering of flag, it shall be:
 - solemn and slow and
 - persons present must act properly (same with raising a flag).



➤ The National Flag shall be flown at half-mast in buildings and places during the announcement of death of the following officials:

- (A) 10 days
 - ✓ President
 - ✓ Former-President
- (B) 7 days
 - ✓ Vice President
 - ✓ Chief Justice of the Supreme Court
 - ✓ Members of the Senate
 - ✓ Speaker of the House of Representatives
- (C) 5 days
 - ✓ Cabinet Secretaries
 - ✓ Associate Justices of SC
 - ✓ Members of Senate
 - ✓ Members of House of Representatives
 - ✓ Chief of Staff of AFP
 - ✓ Director General of PNP
- (D) 3 days
 - ✓ Heads of National Government Agencies:
 - ❖ Government Owned Corporations and
 - ❖ Controlled Corporations
 - ❖ Government Financial Institutions
- (E) 3 days
 - ✓ Commanding General of AFP
 - ✓ Commanding General of Philippine Army
 - ✓ Flag Offices in Command of Philippine Navy
- (F)
 - ✓ Governors
 - ✓ Vice Governors
 - ✓ City and Municipal Mayors

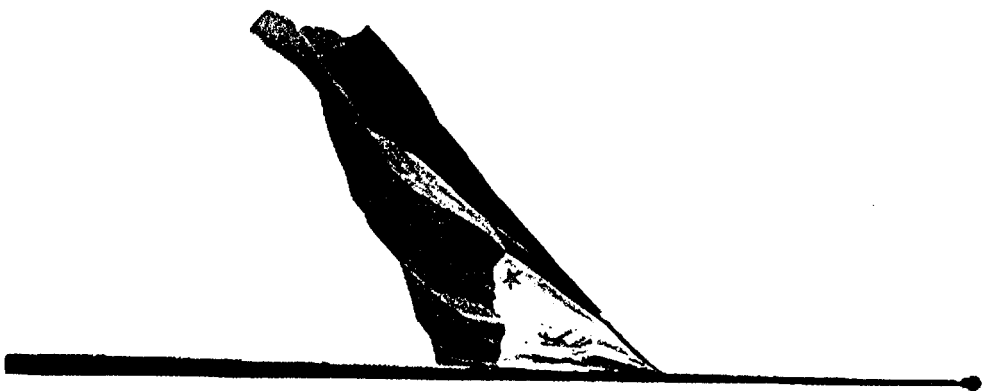

- (G)
 - ✓ Members of Sangguniang Panlalawigan
 - ✓ Members of Sangguniang Panglungsod
 - ✓ Members of Sangguniang Bayan
- (H)
 - ✓ Veterans of previous wars
 - ✓ Barangay Chairpersons
 - ✓ Barangay Councilpersons
- (I)
 - ✓ Former National Officials (appointed or elected)
 - ✓ Local National Officials
- (J)
 - ✓ Regional Directors
 - ✓ Superintendents
 - ✓ Supervisors
 - ✓ Principals
 - ✓ Teachers
 - ✓ School Officials
- (K)
 - ✓ Recipients of National Orders
 - ✓ Recipients of National Decorations
- (L) For a period of less than 7 days
 - ✓ Other persons to be determined by the Institute including:
 - o The former Vice President
 - o Chief Justice of the Supreme Court
 - o President of the Senate and
 - o Speaker of the House

- In cases "c" to "e" the National Flag shall be flown at half-mast in front of the building where the deceased official held office. In cases of "f" to "h" through Sanggunian Resolution or by order of the local Chief Executive.
- The National Flag when flown at half- mast shall be raised to the peak for a moment then lowered to the half-mast position. The National Flag shall again be raised to the peak before it is lowered for the day.
- The National Flag shall be flown at half-mast during the death anniversary of heroes and heroines, calamities or grave adversity or international solemnity as ordered by the Office of the President or as may be recommended by the NHI.
- The National Flag shall be permanently raised at half-mast day and night throughout the year in all memorial cemeteries dedicated to war.

Casket

The National Flag may be used to cover the casket to honor the death of a military, veterans of wars, national artists and civilians who rendered distinguish service to the nation.

No object must be put on top of the National Flag, except for religious objects that symbolize "God above Country."

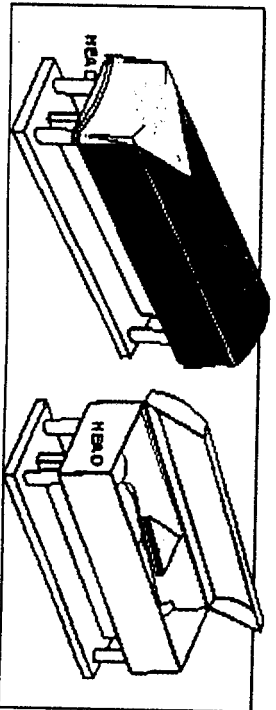

Pledge to the National Flag

- The pledge of allegiance to the National Flag shall be recited after singing the National Anthem, with the right palm open, raised shoulder high.
- From May 28 to June 21, (National Flag Days) all offices, agencies and instrumentalities of government, business, learning institutions, private buildings and homes are enjoined to display the National Flag.
- Government offices and local government units shall display the National Flag on main thoroughfares, parks, plazas, and other public places.

SPECIFICATIONS OF THE NATIONAL FLAG

- The technical specifications shall be as follows:
 - Size
 - Width 1
 - Length 2
 - All the sides of the white triangle 1
- Color
 - The blue color shall bear Cable no. 80173
 - The white color shall bear Cable No. 80001
 - The red color shall bear Cable No. 80108
 - The golden yellow shall bear Cable No. 80068

❖ The assigned cable numbers are listed in the Tenth Edition of the Standard Color Reference of America, created and issued by the color Association of the United States, No. 343 Lexington Avenue, New York, New York, 10016, Series of 1981.

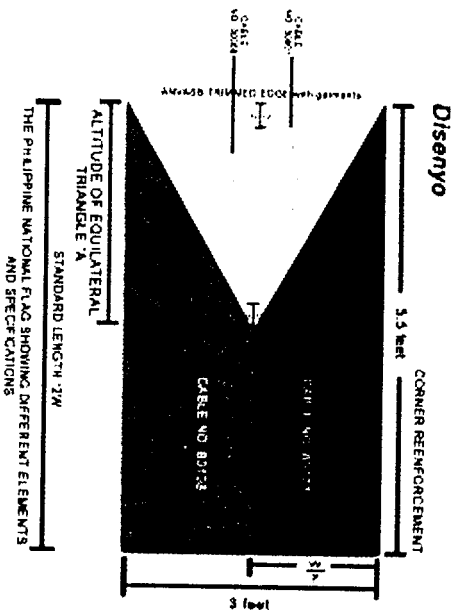

COLOR SWATCH	KURAW	ASUL	PUTI	PULA	MALAGIN-TONG DILAW
CABLE NO.	80173	80001	80108	80068	

HOTLINES ON FLAG ADVOCACY:

(For Public Queries, Inquiries,
Complaints on the Respect
for Flag Advocacy)

- **NHI** : 523-1037 / 523-9050;
523-9043
- **MMD** : 882-4150
- **BOY SCOUTS** : 527-5112 or 527-8317 to
20 loc.225
- **GIRL SCOUTS** : 526-5193
- **KNIGHTS OF RIZAL** : 528-1974 / 521-0141;
0927-448-1115 c/o
Ruby Gonzales
- **DEPED** : 637-5832-34 c/o
Luz dela Rosa
- **DPWH** : 527-9727 / 527-2647
- **DOT** : 525-4611
- **PIA** : 920-4652 / 920-4346

PIA - Planning and communication Research Division with National Historical Institute