



REPUBLIC OF THE PHILIPPINES
DEPARTMENT OF EDUCATION, CULTURE AND SPORTS
Meralco Avenue, Pasig City

OFFICE OF THE SECRETARY

January 26, 1999

DECS ORDER

No. 8, s. 1999

**LIST OF APPROVED TEXTBOOKS AND TEACHER'S MANUALS
FOR SY 1999-2000**

To : Undersecretaries and Assistant Secretaries
Bureau/Center/Regional Directors
School Superintendents
All Others Concerned

1. DECS is pleased to announce the inclosed List of Textbooks and Teacher's Manuals Approved for Use in Public Schools for SY1999-2000 (Annex 1). The list includes the title, publisher, price ceiling, and purchase code of each textbook and teacher's manual duly approved by the DECS Instructional Materials Council (IMC) for use in public elementary and secondary schools. Only materials found in the attached list may be purchased as textbooks and teacher's manuals by DECS Offices.

2. The ceiling prices indicated herein are for government-funded direct purchases of the materials which must adhere to DECS technical specifications (Annex 2). The ceiling prices are inclusive of delivery costs to district offices, in the case of elementary schools, and delivery costs to high schools for purchases made by the DECS Central, Regional and/or Division Offices. DECS Offices may negotiate for discounts from suppliers particularly when large volumes of purchases are involved in order to secure the best terms for the government.

3. A CY1999 DECS Catalogue of Approved Textbooks and Teacher's Manuals containing a brief description of each set of approved material found in the attached list shall be issued and distributed to the various DECS Offices and others concerned. The Catalogue is intended to complement this DECS Order and assist school officials in determining which materials to order. The CY1999 Catalogue shall include new materials approved under the Second Textbook Call and those under the First Textbook Call as contained in the CY1998 DECS Catalogue.

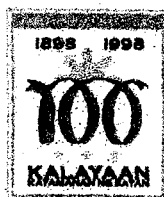

Tel. No. 6337208
Fax No. 6320805

4. The procurement of textbooks and teacher's manuals thru public bidding by either DECS Central or Regional Offices using lumpsum appropriations for this purpose shall be undertaken starting CY1999. This shall be without prejudice to direct purchases of materials included herein which will be allowed subject to certain conditions. Direct purchases of materials shall be allowed when funds other than the lumpsum appropriation for instructional materials (i.e., released to DECS Central and/or Regional Offices) are used (e.g., LGU/SEF funds, savings from MOOE). Direct purchases may also be allowed using amounts from the lumpsum appropriation mentioned above (e.g., balance after bidding) subject to the approval of the DECS Secretary.

5. Any purchase of textbooks and teacher's manuals shall be based on specific requests from the school principals/administrators and/or an updated inventory of available materials in the schools duly certified by the appropriate DECS official(s). The titles and quantities of materials purchased should also be consistent with educational priorities and standards. All concerned are enjoined to exercise judicious care in the procurement of these materials in order to maximize benefits for the schoolchildren.

6. For the information and guidance of all concerned.

Andrew Gonzalez
Andrew Gonzalez, FSC
Secretary *AG*

Incls.:

As stated

Reference:

DECS Orders: Nos. 47, s. 1996 and 104, s. 1997

Allotment: 1—(D.O. 50-97)

To be indicated in the Perpetual Index
under the following subjects:

**LISTS
PURCHASE
TEXTBOOKS**

List of Textbooks and Teacher's Manuals Approved for Use in Public Schools for SY 1999-2000

	TITLE	PUBLISHER	TEACHER'S MNL. PURCHASE CODE	TEXTBOOK PURCHASE CODE
Elementary				
	FILIPINO 1	PRICE CEILING	P 86.75	P 65.80
1	1 Bagong Filipino sa Bagong Sentenaryo 1	Anvil Publishing, Inc.	ME1-F05-AN	XE1-F05-AN
2	2 Bagong Filipino sa Salita at Gawa 1	SD Publications, Inc.	ME1-F01-SD	XE1-F01-SD
3	3 Kayumanggi 1	FNB Educational, Inc.	ME1-F02-FN	XE1-F02-FN
4	4 Landas sa Wika at Pagbasa 1	Dane Publishing House, Inc.	ME1-F06-DA	XE1-F06-DA
5	5 Pagdiriwang ng Wikang Filipino 1	Diwa Scholastic Press, Inc.	ME1-F03-DW	XE1-F03-DW
6	6 Sining sa Wika at Pagbasa 1	J.C. Palabay Enterprises, Inc.	ME1-F04-JC	XE1-F04-JC
	FILIPINO 2	PRICE CEILING	P 86.75	P 65.80
7	1 Bagong Filipino sa Salita at Gawa 2	SD Publications, Inc.	ME2-F01-SD	XE2-F01-SD
8	2 Kayamanan ng Lahi 2	Christian Publishing	ME2-F06-CP	XE2-F06-CP
9	3 Kayumanggi 2	FNB Educational, Inc.	ME2-F02-FN	XE2-F02-FN
10	4 Landas sa Wika at Pagbasa 2	Dane Publishing House, Inc.	ME2-F07-DA	XE2-F07-DA
11	5 Makabagong Sining sa Wika at Pagbasa 2	Miranda BMM	ME2-F03-MB	XE2-F03-MB
12	6 Pagdiriwang ng Wikang Filipino 2	Diwa Scholastic Press, Inc.	ME2-F04-DW	XE2-F04-DW
13	7 Sining sa Wika at Pagbasa 2	J.C. Palabay Enterprises, Inc.	ME2-F05-JC	XE2-F05-JC
	FILIPINO 3	PRICE CEILING	P 93.60	W/P : P 70.45
14	1 Bagong Filipino sa Salita at Gawa 3 (Wika) Bagong Filipino sa Salita at Gawa 3 (Pagbasa)	SD Publications, Inc.	ME3-F01-SD	XE3-F01WSD XE3-F01PSD
15	2 Filipino sa Bagong Henerasyon 3 (Wika) Filipino sa Bagong Henerasyon 3 (Pagbasa)	The Bookmark, Inc.	ME3-F05-BK	XE3-F05WBK XE3-F05PBK
16	3 Filipino - Sagisag ng Lahi 3 (Wika) Filipino - Sagisag ng Lahi 3 (Pagbasa)	Abiva Publishing House, Inc.	ME3-F06-AB	XE3-F06WAB XE3-F06PAB
17	4 Kayumanggi 3 (Wika) Kayumanggi 3 (Pagbasa)	FNB Educational, Inc.	ME3-F02-FN	ME3-F02WFN ME3-F02PFN
18	5 Landas ng Wika at Pagbasa 3 (Wika) Landas ng Wika at Pagbasa 3 (Pagbasa)	Dane Publishing House, Inc.	ME3-F03-DA	ME3-F03WDA ME3-F03PDA
19	6 Pagdiriwang ng Wikang Filipino 3 (Wika) Pagdiriwang ng Wikang Filipino 3 (Pagbasa)	Diwa Scholastic Press, Inc.	ME3-F07-DW	XE3-F07WDW XE3-F07PDW
20	7 Sining sa Wika at Pagbasa 3 (Wika) Sining sa Wika at Pagbasa 3 (Pagbasa)	J.C. Palabay Enterprises, Inc.	ME3-F04-JC	ME3-F04WJC ME3-F04PJC
21	8 Umunlad sa Filipino 3 (Wika) Umunlad sa Filipino 3 (Pagbasa)	Esteem Enterprises	ME3-F08PES	XE3-F08WES XE3-F08PES

CERTIFIED CORRECT:

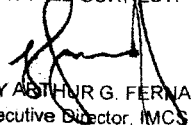
JAY ASTHNR G. FERNANDEZ
Executive Director, IMCS

APPROVED BY:

ANDREW GONZALEZ, FSC
Secretary, DECS

List of Textbooks and Teacher's Manuals Approved for Use in Public Schools for SY 1999-2000

TITLE		PUBLISHER	TEACHER'S MNL. PURCHASE CODE	TEXTBOOK PURCHASE CODE
		PRICE CEILING	P 100.40	W : P 77.75 P : P 70.45
FILIPINO 4				
22	1 Bagong Filipino sa Salita at Gawa 4 (Wika) Bagong Filipino sa Salita at Gawa 4 (Pagbasa)	JGM & S Corporation	ME4-F01-JG	XE4-F01WJG XE4-F01PJG
23	2 Kayumanggi 4 (Wika) Kayumanggi 4 (Pagbasa)	FNB Educational, Inc.	ME4-F02-FN	XE4-F02WFN XE4-F02PFN
24	3 Pagdiriwang ng Wikang Filipino 4 (Wika) Pagdiriwang ng Wikang Filipino 4 (Pagbasa)	Diwa Scholastic Press, Inc.	ME4-F03-DW	XE4-F03WDW XE4-F03PDW
25	4 Sining sa Wika 4 at Pagbasa 4 (Wika) Sining sa Wika 4 at Pagbasa 4 (Pagbasa)	J.C. Palabay Enterprises, Inc.	ME4-F04-JC	XE4-F04WJC XE4-F04PJC
FILIPINO 5				
		PRICE CEILING	P 100.40	WP : P 77.75
26	1 Bagong Filipino sa Salita at Gawa 5 (Wika) Bagong Filipino sa Salita at Gawa 5 (Pagbasa)	JGM & S Corporation	ME5-F01-JG	XE5-F01WJG XE5-F01PJG
27	2 Hiyas sa Pagbasa/Wika 5 (Wika) Hiyas sa Pagbasa/Wika 5 (Pagbasa)	LG & M Corporation	ME5-F02-LG	XE5-F02WLG XE5-F02PLG
28	3 Pagdiriwang ng Wikang Filipino 5 (Wika) Pagdiriwang ng Wikang Filipino 5 (Pagbasa)	Diwa Scholastic Press, Inc.	ME5-F03-DW	XE5-F03WDW XE5-F03PDW
FILIPINO 6				
		PRICE CEILING	P 100.40	WP : P 82.60
29	1 Bagong Filipino sa Salita at Gawa 6 (Wika) Bagong Filipino sa Salita at Gawa 6 (Pagbasa)	JGM & S Corporation	ME6-F01-JG	XE6-F01WJG XE6-F01PJG
30	2 Kayumanggi 6 (Wika) Kayumanggi 6 (Pagbasa)	FNB Educational, Inc.	ME6-F02-FN	XE6-F02WFN XE6-F02PFN
31	3 Landas sa Wika/Pagbasa 6 (Wika) Landas sa Wika/Pagbasa 6 (Pagbasa)	Dane Publishing House, Inc.	ME6-F03-DA	XE6-F03WDA XE6-F03PDA
32	4 Makabagong Sining Wika at Pagbasa 6 (Wika) Makabagong Sining Wika at Pagbasa 6 (Pagbasa)	Miranda BMM	ME6-F04-MB	XE6-F04WMB XE6-F04PMB
33	5 Pagdiriwang ng Wikang Filipino 6 (Wika) Pagdiriwang ng Wikang Filipino 6 (Pagbasa)	Diwa Scholastic Press, Inc.	ME6-F05-DW	XE6-F05WDW XE6-F05PDW
ENGLISH 1				
		PRICE CEILING	P 86.75	P 65.80
34	1 Communicating Is Fun 1	Christian Publishing	ME1-E04-CP	XE1-E04-CP
35	2 Fun in English 1	SD Publications, Inc.	ME1-E05-SD	XE1-E05-SD
36	3 Gates in English 1	Miranda BMM	ME1-E01-MB	XE1-E01-MB
37	4 Growing in English 1	FNB Educational, Inc.	ME1-E02-FN	XE1-E02-FN
38	5 Me and My World 1	Anvil Publishing, Inc.	ME1-E03-AN	XE1-E03-AN

CERTIFIED CORRECT

JAY ARTHUR G. FERNANDEZ
Executive Director, IMCS

APPROVED BY:

ANDREW GONZALEZ, PSC
Secretary, DECS

List of Textbooks and Teacher's Manuals Approved for Use in Public Schools for SY 1999-2000

	TITLE	PUBLISHER	TEACHER'S MNL. PURCHASE CODE	TEXTBOOK PURCHASE CODE
	ENGLISH 2		PRICE CEILING P 86.75	P 65.80
39	1 Communicating is Fun 2	Christian Publishing	ME2-E03-CP	XE2-E03-CP
40	2 Fun in English 2	SD Publications, Inc.	ME2-E01-SD	XE2-E01-SD
41	3 Gates in English 2	Miranda BMM	ME2-E04-MB	XE2-E04-MB
42	4 Growing in English 2	FNB Educational, Inc.	ME2-E02-FN	XE2-E02-FN
43	5 Using English 2	Mary Jo Publishing House, Inc.	ME2-E05-MJ	XE2-E05-MJ
	ENGLISH 3		PRICE CEILING P 93.80	L/R : P 70.45
44	1 Fun in English 3 (Language) Fun in English 3 (Reading)	SD Publications, Inc.	ME3-E01-SD	XE3-E01LSD XE3-E01RSD
45	2 Growing in English 3 (Language) Growing in English 3 (Reading)	FNB Educational, Inc.	ME3-E02-FN	XE3-E02LFN XE3-E02RFN
	ENGLISH 4		PRICE CEILING P 100.40	L : P 85.00 R : P 70.45
46	1 English for All Times 4 (Language) English for All Times 4 (Reading)	JTW Corporation	ME4-E01-JT	XE4-E01LJT XE4-E01RJT
47	2 Fun in English 4 (Language) Fun in English 4 (Reading)	JGM & S Corporation	ME4-E02-JG	XE4-E02LJG XE4-E02RJG
48	3 Growing in English 4 (Language) Growing in English 4 (Reading)	FNB Educational, Inc.	ME4-E03-FN	XE4-E03LFN XE4-E03RFN
	ENGLISH 5		PRICE CEILING P 103.85	L : P 92.30 R : P 82.60
49	1 English for All Times 5 (Language) English for All Times 5 (Reading)	JTW Corporation	ME5-E01-JT	XE5-E01LJT XE5-E01RJT
50	2 Fun in English 5 (Language) Fun in English 5 (Reading)	JGM & S Corporation	ME5-E02-JG	XE5-E02LJG XE5-E02RJG
51	3 Growing in English 5 (Language) Growing in English 5 (Reading)	FNB Educational, Inc.	ME5-E03-FN	XE5-E03LFN XE5-E03RFN
	ENGLISH 6		PRICE CEILING P 107.55	L : P 94.70 R : P 89.85
52	1 English for All Times 6 (Language) English for All Times 6 (Reading)	JTW Corporation	ME6-E01-JT	XE6-E01LJT XE6-E01RJT
53	2 Growing in English 6 (Language) Growing in English 6 (Reading)	FNB Educational, Inc.	ME6-E02-FN	XE6-E02LFN XE6-E02RFN

CERTIFIED CORRECT:

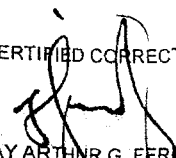
JAY ARTHUR G. FERNANDEZ
Executive Director, IMCS

APPROVED BY:

ANDREW GONZALEZ, FSC
Secretary, DECS

List of Textbooks and Teacher's Manuals Approved for Use in Public Schools for SY 1999-2000

TITLE		PUBLISHER	TEACHER'S MNL. PURCHASE CODE	TEXTBOOK PURCHASE CODE
SCIENCE AND HEALTH 1		PRICE CEILING	P 86.75	P 61.30
54	1 Exploring Science 1	Abiva Publishing House, Inc.	ME1-S11-AB	XE1-S11-AB
55	2 Growing with Science and Health 1	Rex Bookstore Press, Inc.	ME1-S01-RX	XE1-S01-RX
56	3 Into the Future: Science and Health 1	Diwa Scholastic Press, Inc.	ME1-S02-RX	XE1-S02-RX
57	4 Moving Onward with Science and Health 1	Cesty Trading	ME1-S03-CT	XE1-S03-CT
58	5 Our World of Science and Health 1	Books on Wheels Enterprises	ME1-S04-BW	XE1-S04-BW
59	6 Science and Health 1	Current Events Digest, Inc.	ME1-S08-CE	XE1-S08-CE
60	7 Science and Health 1	Miranda BMM	ME1-S05-MB	XE1-S05-MB
61	8 Science and Health 1	Ricsons Enterprises	ME1-S12-RC	XE1-S12-RC
62	9 Science and Health 1	SD Publications, Inc.	ME1-S06-SD	XE1-S06-SD
63	10 Science and Health Today 1	Rex Bookstore, Inc.	ME1-S09-RX	XE1-S09-RX
64	11 Science for Daily Use 1	JICA Enterprises	ME1-S10-JE	XE1-S10-JE
65	12 Science for Everyone 1	Fabi's Enterprises	ME1-S07-FA	ME1-S07-FA
SCIENCE AND HEALTH 2		PRICE CEILING	P 86.75	P 61.30
66	1 Adventures in Science 2	Christian Publishing	ME2-S10-CP	XE2-S10-CP
67	2 Exploring Science 2	Abiva Publishing House, Inc.	ME2-S11-AB	XE2-S11-AB
68	3 Growing with Science and Health 2	Rex Bookstore, Inc.	ME2-S01-RX	XE2-S01-RX
69	4 Into the Future: Science and Health 2	Diwa Scholastic Press, Inc.	ME2-S02-DW	XE2-S02-DW
70	5 Moving Onward with Science and Health 2	Cesty Trading	ME2-S12-CT	XE2-S12-CT
71	6 Progressive Science & Health Series 2	Cultural Publisher	ME2-S13-CU	XE2-S13-CU
72	7 Science and Health 2	Current Events Digest, Inc.	ME2-S03-CE	XE2-S03-CE
73	8 Science and Health 2	SD Publications, Inc.	ME2-S04-SD	XE2-S04-SD
74	9 Science and Health for Life 2	Anvil Publishing, Inc.	ME2-S05-AN	XE2-S05-AN
75	10 Science and Health Today 2	Rex Bookstore, Inc.	ME2-S06-RX	XE2-S06-RX
76	11 Science Around Us 2	Emgee Enterprises	ME2-S07-EM	XE2-S07-EM
77	12 Science for Daily Use 2	JICA Enterprises	ME2-S08-JE	XE2-S08-JE
78	13 Science for Everyone 2	Fabi's Enterprises	ME2-S09-FA	XE2-S09-FA
SCIENCE AND HEALTH 3		PRICE CEILING	P 93.60	P 75.30
79	1 Growing with Science and Health 3	Rex Bookstore, Inc.	ME3-S05-RX	XE3-S05-RX
80	2 Science 3	Current Events Digest, Inc.	ME3-S01-CE	XE3-S01-CE
81	3 Science and Health 3	SD Publications, Inc.	ME3-S02-SD	XE3-S02-SD
82	4 Science Around Us 3	Emgee Enterprises	ME3-S03-EM	XE3-S03-EM
83	5 Science for Everyone 3	Fabi's Enterprises	ME3-S04-FA	XE3-S04-FA
SCIENCE AND HEALTH 4		PRICE CEILING	P 83.30	P 89.85
84	1 Growing with Science and Health 4	Rex Bookstore, Inc.	ME4-S01-RX	XE4-S01-RX
85	2 Into the Future: Science and Health 4	Diwa Scholastic Press, Inc.	ME4-S02-DW	XE4-S02-DW
86	3 Science & Health 4	Miranda BMM	ME4-S03-MB	XE4-S03-MB
87	4 Science and Health 4	SD Publications, Inc.	ME4-S04-SD	XE4-S04-SD
SCIENCE AND HEALTH 5		PRICE CEILING	P 90.15	P 94.70
88	1 Headways in Science and Health Today 5	Rex Bookstore, Inc.	ME5-S01-RX	XE5-S01-RX
89	2 Into the Future: Science and Health 5	Diwa Scholastic Press, Inc.	ME5-S02-DW	XE5-S02-DW

CERTIFIED CORRECT:

JAY ARTHUR G. FERNANDEZ
Executive Director, IMCS

APPROVED BY:

Andrew Gonzalez
ANDREW GONZALEZ, FSC
Secretary, DECS

List of Textbooks and Teacher's Manuals Approved for Use in Public Schools for SY 1999-2000

	TITLE	PUBLISHER	TEACHER'S MNL. PURCHASE CODE	TEXTBOOK PURCHASE CODE
90	3 Science and Health 5	SD Publications, Inc.	ME5-S03-SD	XE5-S03-SD
91	4 Science for Better Health and Environment 5	Bookman, Inc.	ME5-S04-BN	XE5-S04-BN
SCIENCE AND HEALTH 6		PRICE CEILING	P 100.40	P 102.00
92	1 Science and Health 6	SD Publications, Inc.	ME6-S01-SD	XE6-S01-SD
MATHEMATICS 1		PRICE CEILING	P 86.75	P 61.30
93	1 Enjoy the World of Mathematics 1	Christian Publishing	ME1-M04-CP	XE1-M04-CP
94	2 Grade School Mathematics 1	Diwa Scholastic Press, Inc.	ME1-M03-DW	XE1-M03-DW
95	3 Growing in Mathematics 1	Miranda BMM	ME1-M01-MB	XE1-M01-MB
96	4 Growing with Mathematics 1	FNB Educational, Inc.	ME1-M02-FN	XE1-M02-FN
97	5 Keeping Up with New Mathematics 1	Reach Out Educational Resources	ME1-M08-RO	XE1-M08-RO
98	6 Math for Today's Children 1	Rex Bookstore, Inc.	ME1-M07-RX	XE1-M07-RX
99	7 Math for Success 1	Abiva Publishing House, Inc.	ME1-M06-AB	XE1-M06-AB
100	8 Mathematics for Everyday Life 1	JTW Corporation	ME1-M09-JT	XE1-M09-JT
101	9 Mathematics for Everyday Use 1	Dane Publishing House, Inc.	ME1-M05-DA	XE1-M05-DA
102	10 Onward with Mathematics 1	Rex Bookstore, Inc.	ME1-M10-RX	XE1-M10-RX
103	11 Power in Numbers 1	St. Mary's Publishing Corp.	ME1-M11-SM	XE1-M11-SM
MATHEMATICS 2		PRICE CEILING	P 86.75	P 61.30
104	1 Enjoying Mathematics 2	Learning Resources Pub., Inc.	ME2-M01-LR	XE2-M01-LR
105	2 Enjoy the World of Mathematics 2	Christian Publishing	ME2-M08-CP	XE2-M08-CP
106	3 Grade School Mathematics 2	Diwa Scholastic Press, Inc.	ME2-M02-DW	XE2-M02-DW
107	4 Growing in Mathematics 2	Miranda BMM	ME2-M09-MB	XE2-M09-MB
108	5 Growing with Mathematics 2	FNB Educational, Inc.	ME2-M03-FN	XE2-M03-FN
109	6 Learn and Enjoy Mathematics 2	Tividad Publisher	ME2-M04-TP	XE2-M04-TP
110	7 Learning Mathematics the Easy Way 2	Rex Bookstore, Inc.	ME2-M05-RX	XE2-M05-RX
111	8 Mathematics for Everyday Use 2	Dane Publishing House, Inc.	ME2-M06-DA	XE2-M06-DA
112	9 Math for Success 2	Abiva Publishing House, Inc.	ME2-M10-AB	XE2-M10-AB
113	10 Power in Numbers 2	St. Mary's Publishing Corp.	ME2-M07-SM	XE2-M07-SM
MATHEMATICS 3		PRICE CEILING	P 93.60	P 75.30
114	1 Grade School Mathematics 3	Diwa Scholastic Press, Inc.	ME3-M05-DW	XE3-M05-DW
115	2 Growing in Mathematics 3	Miranda BMM	ME3-M06-MB	XE3-M06-MB
116	3 Growing with Mathematics 3	FNB Educational, Inc.	ME3-M07-FN	XE3-M07-FN
117	4 Learning Mathematics the Easy Way 3	Rex Bookstore, Inc.	ME3-M01-RX	XE3-M01-RX
118	5 Math for Success 3	Abiva Publishing House, Inc.	ME3-M08-AB	XE3-M08-AB
119	6 Math for Today's Children 3	Rex Bookstore, Inc.	ME3-M09-RX	XE3-M09-RX
120	7 Math on the Go 3	Rembrandt Manor Publishing Corp.	ME3-M10-RM	XE3-M10-RM
121	8 Mathematics 3	Current Events Digest, Inc.	ME3-M02-CE	XE3-M02-CE
122	9 Mathematics for Everyday Use 3	Dane Publishing House, Inc.	ME3-M03-DA	XE3-M03-DA
123	10 Power in Numbers 3	St. Mary's Publishing Corp.	ME3-M04-SM	XE3-M04-SM

CERTIFIED CORRECT:

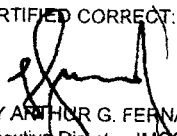
JAY ARTHUR G. FERNANDEZ
Executive Director, IMCS

APPROVED BY:

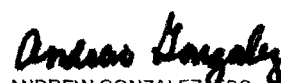
ANDREW GONZALEZ, FSC
Secretary, DECS

List of Textbooks and Teacher's Manuals Approved for Use in Public Schools for SY 1999-2000

TITLE		PUBLISHER	TEACHER'S MNL. PURCHASE CODE	TEXTBOOK PURCHASE CODE
		PRICE CEILING	P 90.15	P 77.75
MATHEMATICS 4				
124	1 Grade School Mathematics 4	Diwa Scholastic Press, Inc.	ME4-M01-DW	XE4-M01-DW
125	2 Growing with Mathematics 4	FNB Educational, Inc.	ME4-M02-FN	XE4-M02-FN
126	3 Math for Daily Use 4	J.C. Palabay Enterprises, Inc.	ME4-M05-JC	XE4-M05-JC
127	4 Math for Success 4	Abiva Publishing House, Inc.	ME4-M06-AB	XE4-M06-AB
128	5 Mathematics for Everyone 4	Lakki Publishing House	ME4-M03-LK	XE4-M03-LK
129	6 Mathematics for Everyday Life 4	JTW Corporation	ME4-M04-JT	XE4-M04-JT
130	7 Power in Numbers 4	St. Mary's Publishing Corp.	ME4-M07-SM	XE4-M07-SM
MATHEMATICS 5				
		PRICE CEILING	P 97.00	P 82.60
131	1 Grade School Mathematics 5	Diwa Scholastic Press, Inc.	ME5-M01-DW	XE5-M01-DW
132	2 Mathematics for Everyday Life 5	JTW Corporation	ME5-M03-JT	XE5-M03-JT
133	3 Mathematics for Everyday Use 5	Dane Publishing House, Inc.	ME5-M02-DA	XE5-M02-DA
MATHEMATICS 6				
		PRICE CEILING	P 100.40	P 89.85
134	1 Enjoying Math 6	Learning Resources Pub., Inc.	ME6-M01-LR	XE6-M01-LR
135	2 Growing with Mathematics 6	FNB Educational, Inc.	ME6-M02-FN	XE6-M02-FN
136	3 Learning Math Today 6	Aklat Publishing House	ME6-M03-AK	XE6-M03-AK
137	4 Mathematics for Everyday Use 6	Dane Publishing House, Inc.	ME6-M04-DA	XE6-M04-DA
138	5 Mathematics in Daily Life 6	JTW Corporation	ME6-M05-JT	XE6-M05-JT
139	6 Power in Numbers 6	St. Mary's Publishing Corp.	ME6-M06-SM	XE6-M06-SM
CIVICS AND CULTURE 1				
		PRICE CEILING	P 86.75	P 61.30
140	1 Ang Bayan Kong Mahal 1	Abiva Publishing House, Inc.	ME1-K01-AB	XE1-K01-AB
141	2 Lahing Pilipino 1	Bookman, Inc.	ME1-K02-BN	XE1-K02-BN
142	3 Munting Mamamayan 1	Merryland Publishing Corporation	ME1-K10-MP	XE1-K10-MP
143	4 Pagsibol ng Lahing Pilipino 1	Diwa Scholastic Press, Inc.	ME1-K03-DW	XE1-K03-DW
144	5 Pilipinas ang Ating Bansa 1	Rex Bookstore, Inc.	ME1-K04-RX	XE1-K04-RX
145	6 Pilipinas: Bansang Minamahal 1	SD Publications, Inc.	ME1-K05-SD	XE1-K05-SD
146	7 Pilipinas: Bayan Mo, Bayan Ko 1	The Bookmark, Inc.	ME1-K06-BK	XE1-K06-BK
147	8 Pilipino Ako, Pilipinas ang Bayan Ko 1	Dane Publishing House, Inc.	ME1-K07-DA	XE1-K07-DA
148	9 Sibika at Kultura 1	Current Events Digest, Inc.	ME1-K08-CE	XE1-K08-CE
149	10 Sibika at Kultura 1	Mhelle L. Publications & Gen. Mdse.	ME1-K09-ML	XE1-K09-ML
150	11 Sibika at Kultura 1	Miranda BMM	ME1-K11-MB	XE1-K11-MB
CIVICS AND CULTURE 2				
		PRICE CEILING	P 86.75	P 61.30
151	1 Ang Bagong Pilipino 2	Mary Jo Publishing House, Inc.	ME2-K08-MJ	XE2-K08-MJ
152	2 Lahing Pilipino 2	Bookman, Inc.	ME2-K01-BM	XE2-K01-BM
153	3 Pagsibol ng Lahing Pilipino 2	Diwa Scholastic Press, Inc.	ME2-K02-DW	XE2-K02-DW
154	4 Pamayanang Pilipino 2	St. Mary's Publishing Corp.	ME2-K03-SM	XE2-K03-SM
155	5 Pilipinas: Bansang Maganda 2	SD Publications, Inc.	ME2-K09-SD	XE2-K09-SD
156	6 Pilipinas: Bayan Mo, Bayan Ko 2	The Bookmark, Inc.	ME2-K04-BK	XE2-K04-BK
157	7 Pilipino Ako, Pilipinas ang Bayan Ko 2	Dane Publishing House, Inc.	ME2-K05-DA	XE2-K05-DA
158	8 Sibika at Kultura 2	Current Events Digest, Inc.	ME2-K06-CE	XE2-K06-CE
159	9 Sibika at Kultura 2	Mhelle L. Publications & Gen. Mdse.	ME2-K07-ML	XE2-K07-ML

CERTIFIED CORRECT:

APPROVED BY:

JAY ARTHUR G. FERNANDEZ
Executive Director, IMCS

Andrew Gonzalez
ANDREW GONZALEZ, PSC
Secretary, DECS

List of Textbooks and Teacher's Manuals Approved for Use in Public Schools for SY 1999-2000

	TITLE	PUBLISHER	TEACHER'S MNL. PURCHASE CODE	TEXTBOOK PURCHASE CODE
CIVICS AND CULTURE 3		PRICE CEILING	P 93.60	P 75.30
160	1 Ang Bayan Kong Mahal 3	Abiva Publishing House, Inc.	ME3-K01-AB	XE3-K01-AB
161	2 Pagsibol ng Lahing Pilipino 3	Diwa Scholastic Press, Inc.	ME3-K02-DW	XE3-K02-DW
162	3 Pilipinas ang Ating Bansa 3	Rex Bookstore, Inc.	ME3-K06-RX	XE3-K06-RX
163	4 Pilipinas: Bansa Marangal 3	SD Publications, Inc.	ME3-K03-SD	XE3-K03-SD
164	5 Pilipino Ako, Pilipinas ang Bayan Ko 3	Dane Publishing House, Inc.	ME3-K05-DA	XE3-K05-DA
165	6 Sibika at Kultura 3	Mhelle L. Publications & Gen. Mdse.	ME3-K04-ML	XE3-K04-ML
CIVICS AND CULTURE 4		PRICE CEILING	P 90.15	P 82.60
166	1 Ang Bayan Kong Mahal 4	Abiva Publishing House, Inc.	ME4-K01-AB	XE4-K01-AB
167	2 Lahing Pilipino 4	Bookman, Inc.	ME4-K02-BN	XE4-K02-BN
168	3 Pagsibol ng Lahing Pilipino 4	Diwa Scholastic Press, Inc.	ME4-K03-DW	XE4-K03-DW
169	4 Pilipinas: Bansa Pinagpala 4	SD Publications, Inc.	ME4-K04-SD	XE4-K04-SD
170	5 Pilipinas: Bayan Mo, Bayan Ko 4	The Bookmark, Inc.	ME4-K05-BK	XE4-K05-BK
171	6 Pilipinas: Perlas ng Silangan 4	J.C. Palabay Enterprises, Inc.	ME4-K06-JC	XE4-K06-JC
172	7 Pilipino Ako, Pilipinas ang Bayan Ko 4	Dane Publishing House, Inc.	ME4-K07-DA	XE4-K07-DA
CIVICS AND CULTURE 5		PRICE CEILING	P 100.40	P 89.85
173	1 Ang Bayan Kong Mahal 5	Abiva Publishing House, Inc.	ME5-K01-AB	XE5-K01-AB
174	2 Lahing Pilipino 5	Bookman, Inc.	ME5-K02-BN	XE5-K02-BN
175	3 Pagsibol ng Lahing Pilipino 5	Diwa Scholastic Press, Inc.	ME5-K03-DW	XE5-K03-DW
176	4 Pilipinas: Bansa Malaya 5	SD Publications, Inc.	ME5-K04-SD	XE5-K04-SD
177	5 Pilipino Ako, Pilipinas ang Bayan Ko 5	Dane Publishing House, Inc.	ME5-K05-DA	XE5-K05-DA
178	6 Pilipino... Pilipinas Isang Kasaysayan 5	Mary Jo Publishing House, Inc.	ME5-K06-MJ	XE5-K06-MJ
CIVICS AND CULTURE 6		PRICE CEILING	P 107.55	P 94.70
179	1 Ang Bayan Kong Mahal 6	Abiva Publishing House, Inc.	ME6-K01-AB	XE6-K01-AB
180	2 Pagsibol ng Lahing Pilipino 6	Diwa Scholastic Press, Inc.	ME6-K02-DW	XE6-K02-DW
181	3 Pilipinas: Bansa Papaunlad 6	SD Publications, Inc.	ME6-K03-SD	XE6-K03-SD
GOOD MANNERS AND RIGHT CONDUCT 1		PRICE CEILING	P 86.75	P 61.30
182	1 Ang Batang Huwaran 1	Cesty Trading	ME1-G09-CT	XE1-G09-CT
183	2 Ang Ulirang Pilipino 1	Abiva Publishing House, Inc.	ME1-G10-AB	XE1-G10-AB
184	3 Edukasyon sa Wastong Pag-uugali at Kagandahang Asal 1	Current Events Digest, Inc.	ME1-G01-CE	XE1-G01-CE
188	7 Huwaran Ka, Batang Pilipino 1	PLL Publishing House	ME1-G02-PL	XE1-G02-PL
185	4 Kagandahang Asal at Wastong Pag-uugali 1	Bookman, Inc.	ME1-G03-BN	XE3-G03-BN
186	5 Kagandahang Asal at Wastong Pag-uugali 1	Christian Publishing	ME1-G11-CP	XE1-G11-CP
187	6 Kagandahang Asal at Wastong Pag-uugali 1	FNB Educational, Inc.	ME1-G04-FN	XE1-G04-FN
189	8 Pilipino sa Ugali at Asal 1	Rex Bookstore, Inc.	ME1-G05-RX	XE1-G05-RX
190	9 Salamin ng Kagandahang Asal at Wastong Pag-uugali 1	Miranda BMM	ME1-G06-MB	XE1-G06-MB
191	10 Uliran 1	Jave Publishing House	ME1-G07-JA	ME1-G07-JA
192	11 Ulirang Mag-aaral 1	Merryland Publishing Corporation	ME1-G12-MP	XE1-G12-MP
193	12 Wastong Pag-uugali sa Makabagong Panahon 1	Adriana Printing Co., Inc.	ME1-G08-AD	XE1-G08-AD

CERTIFIED CORRECT

JAY ARNOLD G. FERNANDEZ
Executive Director, IMCS

APPROVED BY:

Andrew Gonzalez
ANDREW GONZALEZ, FSC
Secretary, DECS

List of Textbooks and Teacher's Manuals Approved for Use in Public Schools for SY 1999-2000

TITLE	PUBLISHER	TEACHER'S MNL. PURCHASE CODE	TEXTBOOK PURCHASE CODE
GOOD MANNERS AND RIGHT CONDUCT 2		PRICE CEILING	P 86.75
194 1 Ang Ulirang Pilipino 2	Abiva Publishing House, Inc.	ME2-G05-AB	XE2-G05-AB
195 2 Huwaran Ka, Batang Pilipino 2	PLL Publishing House	ME2-G01-PL	XE2-G01-PL
196 3 Kagandahang Asal at Wastong Pag-uugali 2	FNB Educational, Inc.	ME2-G02-FN	XE2-G02-FN
197 4 Pilipino sa Ugali at Asal 2	Rex Bookstore, Inc.	ME2-G03-RX	XE2-G03-RX
198 5 Uliran 2	Jave Publishing House, Inc.	ME2-G04-PJA	XE2-G04-PJA
199 6 Ulirang Mag-aaral 2	Merryland Publishing Corporation	ME2-G06-MP	XE2-G06-MP
200 7 Wastong Pag-uugali sa Makabagong Panahon 2	Adriana Printing Co., Inc.	ME2-G07-AD	XE2-G07-AD
GOOD MANNERS AND RIGHT CONDUCT 3		PRICE CEILING	P 93.60
201 1 Ang Ulirang Pilipino 3	Abiva Publishing House, Inc.	ME3-G06-AB	XE3-G06-AB
202 2 Kagandahang Asal at Wastong Pag-uugali 3	Christian Publishing	ME3-G07-CP	XE3-G07-CP
203 3 Huwaran Ka, Batang Pilipino 3	PLL Publishing House	ME3-G01-PL	XE3-G01-PL
204 4 Kagandahang Asal at Wastong Pag-uugali 3	FNB Educational, Inc.	ME3-G02-FN	XE3-G02-FN
205 5 Salamin ng Kagandahang Asal at Wastong Pag-uugali 3	Miranda BMM	ME3-G03-MB	XE3-G03-MB
206 6 Pilipino sa Ugali at Asal 3	Rex Bookstore, Inc.	ME3-G09-RX	XE3-G09-RX
207 7 Ulirang Mag-aaral: Makadiyos, Makabayan 3	Merryland Publishing Corporation	ME3-G04-MP	XE3-G04-MP
208 8 Wastong Pag-uugali at Asal sa Makabagong Panahon 3	Lakki Publishing House	ME3-G08-LK	XE3-G08-LK
209 9 Wastong Pag-uugali sa Makabagong Panahon 3	Adriana Printing Co., Inc.	ME3-G05-AD	XE3-G05-AD
GOOD MANNERS AND RIGHT CONDUCT 4		PRICE CEILING	P 86.75
210 1 Ang Batang Huwaran 4	Cesty Trading	ME4-G01-CT	XE4-G01-CT
211 2 Kagandahang Asal at Wastong Pag-uugali 4	FNB Educational, Inc.	ME4-G02-FN	XE4-G02-FN
212 3 Liwanag 4	J.C. Palabay Enterprises, Inc.	ME4-G03-JC	XE4-G03-JC
213 4 Pilipino sa Ugali at Asal 4	Rex Bookstore, Inc.	ME4-G04-RX	XE4-G04-RX
214 5 Salamin ng Kagandahang Asal at Wastong Pag-uugali 4	Miranda BMM	ME4-G05-MB	XE4-G05-MB
215 6 Uliran 4	Jave Publishing House, Inc.	ME4-G06-JA	XE4-G06-JA
216 7 Wastong Pag-uugali sa Makabagong Panahon 4	Adriana Printing Co., Inc.	ME4-G07-AD	XE4-G07-AD
GOOD MANNERS AND RIGHT CONDUCT 5		PRICE CEILING	P 90.15
217 1 Ang Batang Huwaran 5	Cesty Trading	ME5-G01-CT	XE5-G01-CT
218 2 Kagandahang Asal at Wastong Pag-uugali 5	FNB Educational, Inc.	ME5-G02-FN	XE5-G02-FN
219 3 Liwanag 5	J.C. Palabay Enterprises, Inc.	ME5-G03-JC	XE5-G03-JC
220 4 Pilipino sa Ugali at Asal 5	Rex Bookstore, Inc.	ME5-G04-RX	XE5-G04-RX
221 5 Salamin ng Kagandahang Asal at Wastong Pag-uugali 5	Miranda BMM	ME5-G05-MB	XE5-G05-MB
222 6 Uliran 5	Jave Publishing House, Inc.	ME5-G06-JA	XE5-G06-JA
223 7 Wastong Pag-uugali sa Makabagong Panahon 5	Adriana Printing Co., Inc.	ME5-G07-AD	XE5-G07-AD
GOOD MANNERS AND RIGHT CONDUCT 6		PRICE CEILING	P100.40
224 1 Ang Batang Huwaran 6	Cesty Trading	ME6-G01-CT	XE6-G01-CT
225 2 Liwanag 6	J.C. Palabay Enterprises, Inc.	ME6-G02-JC	XE6-G02-JC
226 3 Pilipino sa Ugali at Asal 6	Rex Bookstore, Inc.	ME6-G03-RX	XE6-G03-RX
227 4 Wastong Pag-uugali sa Makabagong Panahon 6	Adriana Printing Co., Inc.	ME6-G04-AD	XE6-G04-AD

CERTIFIED CORRECT:

JAY ARTHUR G. FERNANDEZ
Executive Director, IMCS

APPROVED BY:

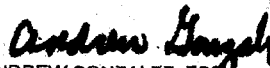
ANDREW GONZALEZ, FSO
Secretary, DECS

List of Textbooks and Teacher's Manuals Approved for Use in Public Schools for SY 1999-2000

	TITLE	PUBLISHER	TEACHER'S MNL. PURCHASE CODE	TEXTBOOK PURCHASE CODE
	MUSIC AND ART 3		PRICE CEILING P 66.25	P 50.15
228	1 Umawit at Gumuhit 3	St. Mary's Publishing Corp.	ME3-A01-SM	XE3-A01-SM
	MUSIC AND ART 4		PRICE CEILING P 66.25	P 59.10
229	1 Musika at Sining 4	Tawid Publications	ME4-A01-TA	XE4-A01-TA
230	2 Umawit at Gumuhit 4	St. Mary's Publishing Corp.	ME4-A02-SM	XE4-A02-SM
	MUSIC AND ART 5		PRICE CEILING P 73.05	P 65.80
231	1 Musika at Sining 5	Tawid Publications	ME5-A01-TA	XE5-A01-TA
232	2 Umawit at Gumuhit 5	St. Mary's Publishing Corp.	ME5-A02-SM	XE5-A02-SM
	MUSIC AND ART 6		PRICE CEILING P 79.90	P 70.45
233	1 Musika at Sining 6	Tawid Publications	ME6-A01-TA	XE6-A01-TA
234	2 Umawit at Gumuhit 6	St. Mary's Publishing Corp.	ME6-A02-SM	XE6-A02-SM
	PHYSICAL EDUCATION 3		PRICE CEILING P 45.75	P 34.50
235	1 Dunong Tulong Pangkalusugan 3	Christian Publishing	ME3-P04-CP	XE3-P04-CP
236	2 Katawan, Kalusugan Ay Kayamanan 3	Anvil Publishing, Inc.	ME3-P01-AN	XE3-P01-AN
237	3 Maunlad ang Batang Malakas 3	Esteem Enterprises	ME3-P02-ES	XE3-P02-ES
238	4 Tayo Nang Magpalakas 3	SD Publications, Inc.	ME3-P03-SD	XE3-P03-SD
	HELE 4		PRICE CEILING P 66.25	P 70.45
239	1 Makabuluhang Gawaing Pangkabuhayan 4	Adriana Printing Co., Inc.	ME4-T01-AD	XE4-T01-AD
240	2 Maunlad na Pamumuhay 4	Tru-Copy Publishing House Inc.	ME4-T02-TR	XE4-T02-TR
241	3 Pagsisikap at Pamumuhay 4	Abiva Publishing House, Inc.	ME4-T03-AB	XE4-T03-AB
242	4 Sa Daigdig ng Gawain 4	Rex Bookstore, Inc.	ME4-T04-RX	XE4-T04-RX
	HELE 5		PRICE CEILING P 66.25	P 75.30
243	1 Makabuluhang Gawaing Pangkabuhayan 5	Adriana Printing Co., Inc.	ME5-T01-AD	XE5-T01-AD
	HELE 6		PRICE CEILING P 66.25	P 77.75
244	1 Makabuluhang Gawaing Pangkabuhayan 6	Adriana Printing Co., Inc.	ME6-T01-AD	XE6-T01-AD
245	2 Sa Daigdig ng Gawain 6	Rex Bookstore, Inc.	ME6-T02-RX	XE6-T02-RX
High School				
	FILIPINO I		PRICE CEILING P 115.30	P 89.00
246	1 Filipino sa Bagong Henerasyon I	The Bookmark, Inc.	MS1-F01-BK	XS1-F01-BK
247	2 Gintong Pamana: Wika at Panitikan I	SD Publications, Inc.	MS1-F02-SD	XS1-F02-SD
248	3 Kadluan ng Wika at Panitikan I	Diwa Scholastic Press, Inc.	MS1-F03-DW	XS1-F03-DW
249	4 Landas sa Wika at Panitikan I	Dane Publishing House, Inc.	MS1-F04-DA	XS1-F04-DA

CERTIFIED CORRECT:

JAY ARTHUR G. FERNANDEZ
Executive Director, IMGS

APPROVED BY:

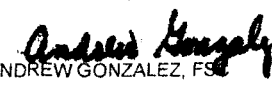
ANDREW GONZALEZ, FS
Secretary, DECS

List of Textbooks and Teacher's Manuals Approved for Use in Public Schools for SY 1999-2000

TITLE		PUBLISHER	TEACHER'S MNL. PURCHASE CODE	TEXTBOOK PURCHASE CODE
		PRICE CEILING	P 115.30	P 89.00
FILIPINO II				
250	1 Batikan ng Lahi II	Win San Printer	MS2F05-WN	XS2F05-WN
251	2 Daloy ng Diwa II	Trinitas Publishing Inc.	MS2-F06-TS	XS2-F06-TS
252	3 Filipino II	Current Events Digest, Inc.	MS2-F01-CE	XS2-F01-CE
253	4 Filipino sa Bagong Henerasyon II	The Bookmark, Inc.	MS2-F07-BK	XS2-F07-BK
254	5 Gintong Pamana: Wika at Panitikan II	SD Publications, Inc.	MS2-F02-SD	XS2-F02-SD
255	6 Kadluan ng Wika at Panitikan II	Diwa Scholastic Press, Inc.	MS2-F03-DW	XS2-F03-DW
256	7 Parola II	Jave Publishing House	MS2-F04-JA	XS2-F04-JA
FILIPINO III				
		PRICE CEILING	P 151.20	P 122.00
257	1 Diwang Filipino III	FNB Educational, Inc.	MS3-F01-FN	XS3-F01-FN
258	2 Filipino sa Bagong Henerasyon III	The Bookmark, Inc.	MS3-F02-BK	XS3-F02-BK
259	3 Kadluan ng Wika at Panitikan III	Diwa Scholastic Press, Inc.	MS3-F03-DW	XS3-F03-DW
260	4 Timbulan III	J.C. Palabay Enterprises, Inc.	MS3-F04-JC	XS3-F04-JC
FILIPINO IV				
		PRICE CEILING	P 151.20	P 137.20
261	1 Filipino IV	Current Events Digest, Inc.	MS4-F01-CE	XS4-F01-CE
262	2 Filipino sa Bagong Henerasyon IV	The Bookmark, Inc.	MS4-F02-BK	XS4-F02-BK
263	3 Kadluan ng Wika at Panitikan IV	Diwa Scholastic Press, Inc.	MS4-F03-DW	XS4-F03-DW
264	4 Timbulan IV	J.C. Palabay Enterprises, Inc.	MS4-F04-JC	XS4-F04-JC
265	5 Wika at Panitikan IV	JGM & S Corporation	MS4-F05-JG	XS4-F05-JG
ENGLISH I				
		PRICE CEILING	P 115.30	P 89.00
266	1 Communication Arts and Skills I	Anvil Publishing, Inc.	MS1-E01-AN	XS1-E01-AN
267	2 Communication for Progress I	Christian Publishing	MS1-E04-CP	XS1-E04-CP
268	3 Learning Effective English I	Adriana Printing Co., Inc.	MS1-E02-AD	XS1-E02-AD
269	4 Making Meaning I	The Bookfarm Inc.	MS1-E05-TB	XS1-E05-TB
270	5 Moving Ahead in English I	FNB Educational, Inc.	MS1-E03-FN	XS1-E03-FN
271	6 New Horizons in Learning English I	Rex Bookstore, Inc.	MS1-E06-RX	XS1-E06-RX
ENGLISH II				
		PRICE CEILING	P 115.30	P 89.00
272	1 Cascades II	Anvil Publishing, Inc.	MS2-E02-AN	XS2-E02-AN
273	2 Meeting My Needs for English II	Rex Bookstore, Inc.	MS2-E03-RX	XS2-E03-RX
274	3 Moving Ahead in English II	FNB Educational, Inc.	MS2-E01-FN	XS2-E01-FN
ENGLISH III				
		PRICE CEILING	P 151.20	P 106.75
275	1 English Arts III	JTW Corporation	MS3-E01-JT	XS3-E01-JT
276	2 New Horizons in Learning English III	Rex Bookstore, Inc.	MS3-E02-RX	XS3-E02-RX
ENGLISH IV				
		PRICE CEILING	P 151.20	P 132.15
277	1 English Arts IV	JTW Corporation	MS4-E01-JT	XS4-E01-JT
278	2 English Communication Arts IV	JGM & S Corporation	MS4-E02-JG	XS4-E02-JG
279	3 Meeting My Needs for English IV	Rex Bookstore, Inc.	MS4-E03-RX	XS4-E03-RX
280	4 Moving Ahead in English IV	FNB Educational, Inc.	MS4-E04-FN	XS4-E04-FN

CERTIFIED CORRECT:

JAY ARTHUR G. FERNANDEZ
Executive Director, IMCS

APPROVED BY:

Andrew Gonzalez, JSC
Secretary, DECS

List of Textbooks and Teacher's Manuals Approved for Use in Public Schools for SY 1999-2000

	TITLE	PUBLISHER	TEACHER'S MNL. PURCHASE CODE	TEXTBOOK PURCHASE CODE
	SCIENCE AND TECHNOLOGY I		PRICE CEILING P 115.30	P 89.00
281	1 Integrated Science I	Abiva Publishing House, Inc.	MS1-S01-AB	XS1-S01-AB
282	2 Science and Technology I	SD Publications, Inc.	MS1-S03-SD	XS1-S03-SD
283	3 Science & Technology for the Modern World I	Diwa Scholastic Press, Inc.	MS1-S04-DW	XS1-S04-DW
284	4 Science and Technology I: Integrated Science	Anvil Publishing, Inc.	MS1-S02-AN	XS1-S02-AN
	SCIENCE AND TECHNOLOGY II		PRICE CEILING P 115.30	P 89.00
285	1 Science and Technology II : Biology	SD Publications, Inc.	MS2-S01-SD	XS2-S01-SD
	SCIENCE AND TECHNOLOGY III		PRICE CEILING P 151.20	P 137.20
286	1 Science and Technology III: Chemistry	SD Publications, Inc.	MS3-S01-SD	XS3-S01-SD
	SCIENCE AND TECHNOLOGY IV		PRICE CEILING P 151.20	P 152.45
287	1 Science and Technology IV: Physics	SD Publications, Inc.	MS4-S01-SD	XS4-S01-SD
	MATHEMATICS I		PRICE CEILING P 115.30	P 89.00
288	1 Dynamic Math I	Diwa Scholastic Press, Inc.	MS1-M01-DW	XS1-M01-DW
289	2 Mathematics I	Current Events Digest, Inc.	MS1-M03-CE	XS1-M03-CE
290	3 Moving Ahead with Mathematics I	FNB Educational, Inc.	MS1-M02-FN	XS1-M02-FN
	MATHEMATICS II		PRICE CEILING P 115.30	P 89.00
291	1 Dynamic Math II	Diwa Scholastic Press, Inc.	MS2-M01-DW	XS2-M01-DW
292	2 Moving Ahead with Mathematics II	FNB Educational, Inc.	MS2-M02-FN	XS2-M02-FN
	MATHEMATICS III		PRICE CEILING P 151.20	P 111.80
293	1 Dynamic Math III	Diwa Scholastic Press, Inc.	MS3-M01-DW	XS3-M01-DW
	SOCIAL STUDIES I		PRICE CEILING P 115.30	P 89.00
294	1 Ang Pilipinas: Heograpiya, Kasaysayan at Pamahalaan I	Saint Bernadette Publication, Inc.	MS1-K01-SB	XS1-K01-SB
295	2 Daloy ng Kasaysayan at Pamahalaang Pilipino I	Dane Publishing House, Inc.	MS1-K02-DA	XS1-K02-DA
296	3 Pagbabago I	Rex Bookstore, Inc.	MS1-K04-RX	XS1-K04-RX
297	4 Pilipinas: Kasaysayan at Pamahalaan I	SD Publications, Inc.	MS1-K03-SD	XS1-K03-SD
	SOCIAL STUDIES II		PRICE CEILING P 115.30	P 89.00
298	1 Asya: Noon, Ngayon at sa Hinaharap II	SD Publications, Inc.	MS2-K01-SD	XS2-K01-SD
	SOCIAL STUDIES III		PRICE CEILING P 151.20	P 106.75
299	1 Araling Pantipunan III: Kasaysayan ng Daigdig	SD Publications, Inc.	MS3-K01-SD	XS3-K01-SD

CERTIFIED CORRECT:

JAY ARTHUR G. FERNANDEZ
Executive Director, IMCS

APPROVED BY:

ANDREW GONZALEZ, FSC
Secretary, DECS

List of Textbooks and Teacher's Manuals Approved for Use in Public Schools for SY 1999-2000

	TITLE	PUBLISHER	TEACHER'S MNL. PURCHASE CODE	TEXTBOOK PURCHASE CODE
	SOCIAL STUDIES IV		PRICE CEILING P 151.20	P 137.20
300	1 Araling Panlipunan IV: Ekonomiks	SD Publications, Inc.	MS4-K01-SD	XS4-K01-SD
301	2 Pagbabago IV	Rex Bookstore, Inc.	MS4-K02-RX	XS4-K02-RX
	VALUES EDUCATION I		PRICE CEILING P 115.30	P 89.00
302	1 Mahalaga Ako I	Anvil Publishing, Inc.	MS1-G01-AN	XS1-G01-AN
	VALUES EDUCATION III		PRICE CEILING P 151.20	P 106.75
303	1 Bayan: Makatao at Maunlad na Lipunan III	Rex Bookstore, Inc.	MS3-G01-RX	XS3-G01-RX
	VALUES EDUCATION IV		PRICE CEILING P 151.20	P 105.50
304	1 Isang Mundo, Isang Maylalang IV	Rex Bookstore, Inc.	MS4-G01-RX	XS4-G01-RX
	MUSIC AND ART I		PRICE CEILING P 69.60	P 59.50
305	1 Musika at Sining I	FNB Educational, Inc.	MS1-A01-FN	XS1-A01-FN
	MUSIC AND ART II		PRICE CEILING P 69.60	P 59.50
306	1 Musika at Sining II	FNB Educational, Inc.	MS2-A01-FN	XS2-A01-FN
	PEHM III		PRICE CEILING P 151.20	P 106.75
307	1 Edukasyong Pangkatawan, Kalusugan at Musika III	FNB Educational, Inc.	MS3-P01-FN	XS3-P01-FN
	PEHM IV		PRICE CEILING P 151.20	P 106.75
308	1 Edukasyong Pangkatawan, Kalusugan at Musika IV	FNB Educational, Inc.	MS4-P01-FN	XS4-P01-FN
	TECHNOLOGY AND HOME ECONOMICS I		PRICE CEILING P 115.30	P 89.00
309	1 Effective Technology and Home Economics I	Adriana Printing Co., Inc.	MS1-T01-AD	XS1-T01-AD
	TECHNOLOGY AND HOME ECONOMICS III		PRICE CEILING	TX : P 61.85
310	1 Effective Technology & Home Economics III (Electricity)	Adriana Printing Co., Inc.		XS3-T01-AD
	TECHNOLOGY AND HOME ECONOMICS IV		PRICE CEILING	TX1: P61.85 TX2: P 106.75
311	1 Civil Technology IV	Abiva Publishing House, Inc.		XS4-T01-AB
312	2 Effective Technology & Home Economics IV (H. E.)	Adriana Printing Co., Inc.		XS4-T02-AD

CERTIFIED CORRECT:

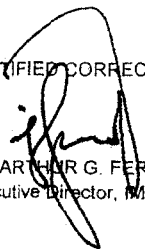
JAY ARTHUR G. FERNANDEZ
Executive Director, MICS

APPROVED BY:

ANDREW GONZALEZ, FSC
Secretary, DECS

Prescribed Paper, Printing, Binding, and Packaging Specifications

Paper

- * The paper shall conform to the physical requirements given in the following table

BODY STOCK/Uncoated Offset Textpaper

Pulping process	:	Semi-mechanical
Basis weight	:	54 gsm, \pm 5%
Brightness	:	68% GE, minimum
Opacity	:	88% GE, minimum
Caliper (Thickness)	:	64 microns, target; 100 microns, maximum
Tensile strength		
MD	:	2.0 kN/m, minimum
CD	:	1.1 kN/m, minimum
Tear resistance		
MD	:	345 mN, minimum
CD	:	390 mN, minimum
Color/Shade	:	White, yellow shade
Texture	:	Vellum/Smooth

COVER STOCK/Solid Bleached Board

Basis weight	:	230 gsm \pm 2%
Caliper	:	290 microns, minimum
Tear resistance		
MD	:	1814.23 mN, minimum
CD	:	1912.30 mN, minimum
Stiffness		
MD	:	4984 mg., minimum
CD	:	1869 mg., minimum
Formation	:	Formation shall be close, uniform, and free from pinholes. The paper shall lie flat with No tendency to curl under normal conditions.
Runnability	:	The paper should be free from mechanical Imperfection and loose materials, and should Be capable of being run on a web printing press. It should also be non-reactive to printing chemicals like fountain etch.

Printing

- * Printing Process : Offset lithography
- * Supplementary Process
1. An overprint varnish shall be adequately applied on the outside cover as a protective coating against rubbing and scratching.
 2. The overprint varnish must be resistant to scuff, heat, and chemicals.
 3. The varnish must have a smooth finish.

- * Color for Textbook (Minimum)
 - * Inside Pages : One (1) color
 - * Cover : Four (4) colors

- * Color for Teacher's Manual (Minimum)
 - * Inside Pages : One (1) color
 - * Cover : One (1) color

- * Ink : Only first class brand base ink for cover printing

Binding

- a. Perfect binding.
- b. The binding adhesive shall be of high grade chemical glue, insect repellent and impervious to moisture and temperature changes. Only hot melt binding adhesive shall be used.

Packing

- a. The books shall be delivered in unused corrugated cartons packed and sealed to withstand rough handling.
- b. Each carton shall contain thirty (30) books wrapped and sealed in sets of ten (10) in a 3-mil thick polyethelene plain plastic bag or vacuum packed using gauge 75 Polyolefin Film (POF) for adequate protection against moisture and water damage. Textbooks and Teacher's Manuals of twenty (20) copies or less shall be contained in prescribed plastic bags, separately wrapped with Kraft paper, and affixed with complete labels found in the DECS prescribed cartons. The wrapper shall be secured by 12.7 mm plastic straps with tin or other appropriate seal.
- c. The carton materials shall have these specifications as shown in Annex E.
 - 1. Corrugation : A, B, C flute
 - 2. Burst Strength : $14.09 \text{ kgs/cm}^2 \pm 2\%$ tolerance
 - 3. Joint : Taped with 50.7 mm wide sisal tapes with fiber and asphalt lamination or equivalent. Boxes with books shall be reinforced with at least 12.7 mm wide plastic strap with tin or other appropriate seal.
 - 4. Top and Bottom Flap Ceiling : 50.8 mm Package Tape or its equivalent
- d. The following information shall be printed in one (1) color on the carton in accordance with the specifications and layout to be furnished by the PURCHASER.
 - 1. Book Title
 - 2. Purchaser's Seal
 - 3. Legal Notice
 - 4. Purchaser's Address
 - 5. Supplier's Code
 - 6. Number of Books in the Carton
 - 7. International symbol, Linear Specifications, Volume & Gross Weight
 - 8. Purchaser's Name

Exploring Science 3

Science & Health for Grade 3 Textbook



Department of Education, Culture and Sports
NASA Complex, Pasig City, Philippines

30 copies

ALLOTTED TO:

REGION : _____ DIVISION: _____

DISTRICT: _____ SCHOOL: _____

NOTE: PUBLISHER MUST DELIVER THESE BOOKS TO DISTRICT OFFICES IN THE CASE OF ELEMENTARY BOOKS AND TO HIGH SCHOOLS IN THE CASE OF SECONDARY BOOKS.

**Government Property
NOT FOR SALE**

Pilipinas Publishing House
369 Datu Humabon St., Bayanihan
Village, Kawit, Cavite

SIDE B

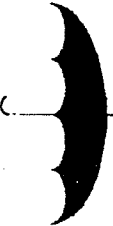
 <p>This side up</p>	 <p>Keep dry</p>
<p>DIMENSIONS</p> <p>Length _____ cm Width _____ cm Height _____ cm</p>	<p>VOLUME _____ cu m GROSS WEIGHT _____ kg</p>

PACKAGE SPECIFICATIONS

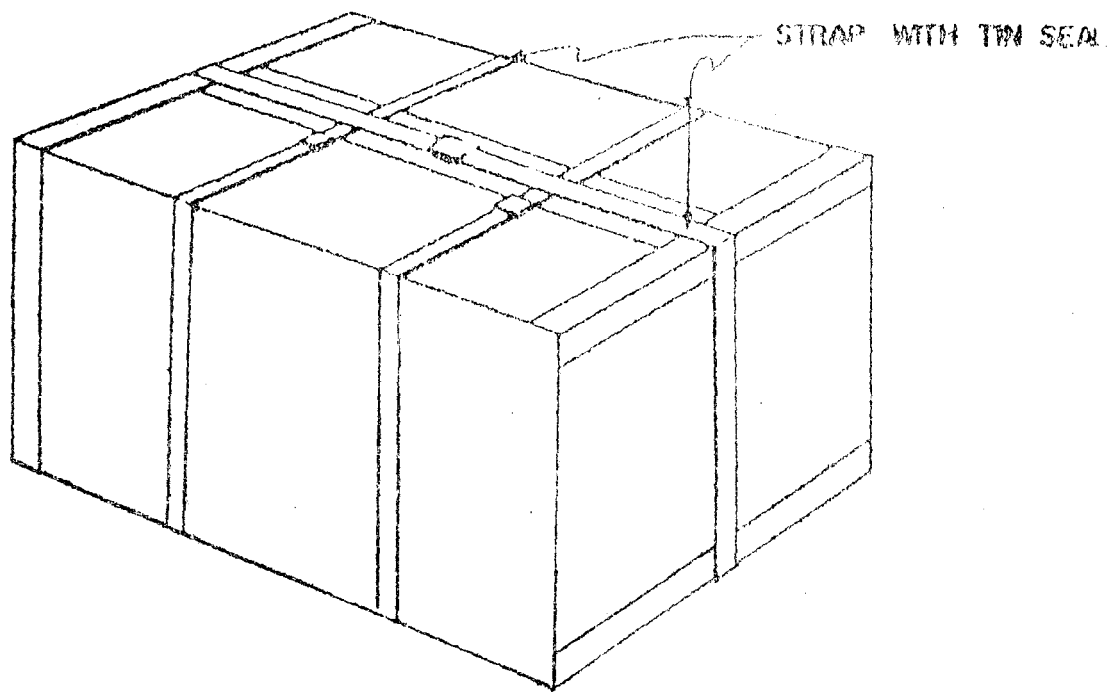

PERSPECTIVE

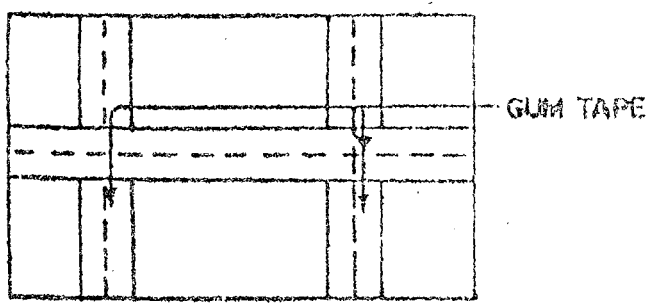

INSIDE BOTTOM VIEW

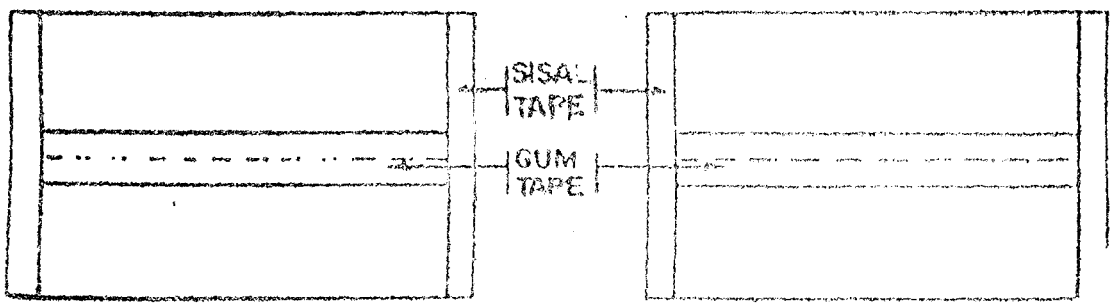

OUTSIDE BOTTOM VIEW

OUTSIDE TOP VIEW