



Republic of Philippines
DEPARTMENT OF EDUCATION

DepEd Complex, Meralco Avenue, Pasig City
Trunk Line (08) 632-13-61, Website
<http://www.deped.gov.ph>



PROJECT: Supply, Delivery and Maintenance of DCP Packages

CONTRACT NO.: 2022c-ICTS3(014to015)-BII-RO-011- co21

CONTRACT

THIS CONTRACT made and entered into this JUN 03 2022 day of 2022 by and between DEPARTMENT OF EDUCATION, located at DepEd Complex, Meralco Avenue, Pasig City, Philippines, represented herein by its Undersecretary for Administration, ALAIN DEL B. PASCUA as per Department Order No. 023, s. 2021 (hereinafter referred to as "DEPED"); and REDDOT Representative, JOAN A. ONGONION, with office address at 1817-1825 España corner Prudencio St., Sampaloc, Manila, Philippines, (hereinafter referred to as "REDDOT IMAGING").

DEPED and REDDOT IMAGING are collectively called "PARTIES."

WHEREAS, the Parties entered into a contract on December 3, 2021, herein referred to as the "Original Contract" for the supply, delivery and maintenance of DCP Packages;

WHEREAS, pursuant to Section 51 of the Revised Implementing Rules and Regulations of RA 9184, Repeat Order is allowed as a method of procurement of goods from the previous winning bidder, whenever there is a need to replenish goods procured under a contract previously awarded through Competitive Bidding;

WHEREAS, the repeat order does not result in splitting of contracts; the repeat order is availed of within six (6) months from the date of the Notice to Proceed arising from the Original Contract; the repeat order does not exceed twenty-five percent (25%) of the quantity of each item in the Original Contract;

WHEREAS, REDDOT IMAGING PHILIPPINES, INC. submitted its quotation for Lot Number 3 which is equal to the unit price under the Original Contract;

WHEREAS, DEPED, through its Bids and Awards Committee II resolved to recommend the award of the contract for Lot No. 3 to REDDOT IMAGING PHILIPPINES, INC. in the sum of PHILIPPINE PESOS SIXTY-SEVEN MILLION, EIGHTY-NINE THOUSAND, ONE HUNDRED FORTY-FOUR & 81/100 (Php 67,089,144.81) ONLY, (hereinafter called the "Contract Price") detailed as follows:

[Signature]
RONA S. BUCAM SAN
RedDot Imaging Philippines, Inc.'s Witness

[Signature]
JOAN A. ONGONION
RedDot Imaging Philippines, Inc.

[Signature]
ABRAM Y.C. ABANIL
DEPED's Witness

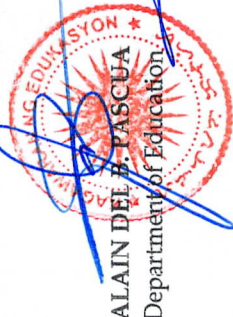

[Signature]
RONA S. PUGANAN
RedDot Imaging Philippines, Inc.'s Witness

[Signature]
JOAN A. ONGONION
RedDot Imaging Philippines, Inc.

[Signature]
ALAIN DEL PASCUA
Department of Education
ABRAMY C. ABANIL
DEPED's Witness

Lot No.	Quantity		Amount (in PhP)
	Laptop	Hard Drive	
3	1,591	1,591	67,089,144.81
	TOTAL		67,089,144.81

NOW THIS CONTRACT WITNESSETH AS FOLLOWS:

1. In this Contract, words and expressions shall have the same meanings as are respectively assigned to them in the Conditions of Contract referred to;
2. The following documents as required by the 2016 Revised Implementing Rules and Regulations of Republic Act No. 9184 shall be deemed to form and be read and construed as part of this Contract, viz:
 - i. Philippine Bidding Documents (PBD):
 - a. Schedule of Requirements;
 - b. Technical Specification;
 - c. General and Special Conditions of the Contract; and
 - ii. Contract No. 2022c-ICTS3(014to015)-BII-RO-011;
 - iii. REDDOT IMAGING PHILIPPINES, INC.' quotation, including the Eligibility requirements, Technical and Financial Proposals, and all other documents or statements submitted under the original contract;
 - iv. Performance Security of the Original Contract;
 - v. Notice of Award of Contract and REDDOT IMAGING PHILIPPINES, INC.' conforme thereto; and
 - vi. Other contract documents required by existing laws and/or DepEd in the PBD. REDDOT IMAGING PHILIPPINES, INC. agrees that additional contract documents or information prescribed by the GPPB that are subsequently required for submission after the contract execution, such as the Notice to Proceed, Variation Order, and Warranty Security, shall form part of the Contract.
3. The Contract shall be performed in accordance with the delivery schedules indicated in the Notice to Proceed (NTP), or in any subsequent instruction duly issued by DEPED.

[Signature]
BONA S. O. BULGALISMA
RedDot Imaging Philippines, Inc.'s Witness

[Signature]
JOAN A. ONGONION
RedDot Imaging Philippines, Inc.

[Signature]
ABRAM Y. C. ABANI
DEPED's Witness

[Signature]
ALAIN DEL ROSARIO
Department of Education



4. The goods supplied under this Contract should conform to the Technical Specifications of the approved samples that were submitted and evaluated during the post-qualification stage of the procurement, a copy of which is hereto attached as Annex "A" and made an integral part hereof. Any proposal to deliver items of equivalent, higher or superior technical specifications, in lieu of those of the approved bids or samples shall be discretionary to DEPED and is subject to the evaluation and recommendation of the end-user or implementing units and the approval of the herein authorized representative and signatory.
5. Goods with defects or non-compliant with the required specifications shall be rejected by DEPED and replaced by REDDOT IMAGING. DEPED shall have the option to inspect REDDOT IMAGING's premises covered by the contract, at any time or stage of contract implementation, to monitor and assess REDDOT IMAGING's capacity to discharge its contractual obligations.
6. In case REDDOT IMAGING encounters condition(s) impeding timely delivery of the goods, REDDOT IMAGING shall promptly notify DEPED in writing of such condition(s) and any request for work suspension and/or contract delivery period extension shall be promptly done in writing as soon as circumstances providing justification for such requests have become apparent. REDDOT IMAGING must provide sufficient proof to support any request for work suspension and/or contract delivery period extension.
7. The Contract Price shall be paid to REDDOT IMAGING in accordance with the following disbursement procedures:
 - 8.1. Upon submission of an irrevocable letter of credit or Bank Guarantee issued by a Universal or Commercial Bank, advance payment not to exceed fifteen percent (15%) of the contract amount shall be allowed and paid within sixty (60) calendar days from signing of the contract;
 - 8.2. REDDOT IMAGING may submit a request for payment based on the monthly Progress Reports which shall be attached to the progress billing and include the following: (i) cumulative quantities of items delivered based on the schedule of delivery and other relevant terms and conditions of the contract; (ii) Inspection and acceptance reports, including certification by REDDOT IMAGING, as approved by the duly authorized representative of DEPED, that the items have been delivered. Other documents in support of a request for payment may be

prescribed by **DEPED** pursuant to existing disbursement, accounting and auditing rules and procedures;

8.3. Subject to the recoupment of the advance payment contemplated in Clause 8.1 above, and retention contemplated in the immediately succeeding clause, payment shall be made to **REDDOT IMAGING** as promptly as possible after the date of acceptance of Goods at **REDDOT IMAGING's** warehouse and upon submission of the documents specified in SCC Clause 2.2 and other documents as may be prescribed by DepEd, in the following manner:

8.3.i. For the initial progress payment, a minimum of 25% of the Contract Price of this lot shall be paid to **REDDOT IMAGING** upon a minimum of 25% delivery of the requirement of this lot and duly accepted by **DEPED's** authorized representative;

8.3.ii. Final payment shall constitute release of the retention money in case of expiry of the warranty period, or whatever is left of it, after it has been called for use under the warranty provision.

9. Payments shall be subject to the "Warranty" provision in the form of either retention money in an amount equivalent to at least three percent (3%) of every progress payment, or a Special Bank Guarantee in the amount equal to at least three percent (3%) of the Contract Price as required under Section 62 of R.A. 9184 and its revised IRR.

9.1. A comprehensive and on-site warranty of three (3) years shall be applied to Laptop and External Hard Drive which shall reckon from the date of issuance of Certificate of Final Acceptance by **DEPED**.

9.2. A standard/base warranty or minimum of one (1) year warranty shall be applied to Laptop Batteries, Optimal Mouse and Keyboards for Laptops and Laptop Headsets.

10. **REDDOT IMAGING** shall be liable for liquidated damages for the delay in its performance of the Contract in an amount equal to one-tenth (1/10) of one percent (1%) of the cost of the delayed goods scheduled for delivery for every day of delay until such goods are finally delivered and accepted by the **DEPED's** authorized representative. **DEPED** shall deduct the liquidated damages from any money due or which may become due to

RONA
RedDot Imaging Philippines, Inc.'s Witness

JOANA A. ONGONION
RedDot Imaging Philippines, Inc.

ABRAM Y.C. ABANI
DEPED's Witness



ALAIN DEL PASCUA
Department of Education

REDDOT IMAGING, or collect from any of the securities or warranties posted by the REDDOT IMAGING, whichever is convenient to DEPED. Once the cumulative amount of liquidated damages reaches ten percent (10%) of the Contract Price, DEPED may rescind or terminate the contract, without prejudice to other courses of action and remedies available under the circumstances.

11. The Parties shall make every effort to resolve amicably and by mutual consultation any and all disputes or differences arising between the parties in connection with the implementation of the Agreement. Should such dispute not be resolved amicably, it shall be submitted to arbitration in the Philippines according to the provisions of Presidential Decree No. 242 and Executive Order No. 292. Provided, however, that by mutual agreement, the parties may agree in writing to resort to other alternative modes of dispute resolution.

IN WITNESS WHEREOF, the Parties hereto have caused this Contract to be executed in accordance with governing laws on the day and year first above written.

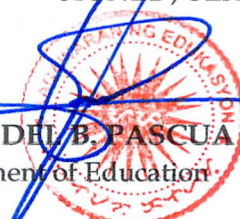
SIGNED, SEALED AND DELIVERED BY:

ALAIN DEL B. PASCUA
Department of Education

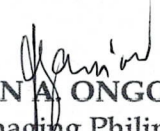
JOAN A. ONGONION
RedDot Imaging Philippines, Inc.

SIGNED IN THE PRESENCE OF:

ABRAM Y.C. ABANIL
DepEd's Witness

RONA S. BUCANISAN
REDDOT IMAGING's Witness

CERTIFIED FUNDS AVAILABLE: ₱67,089,144.81

MA. RHUNNA L. CATALAN
Chief Accountant

REPUBLIC OF THE PHILIPPINES)
_____, METRO MANILA) S.S

MANILA

ACKNOWLEDGMENT

MANILA

BEFORE ME a Notary Public in and for _____
Philippines, this _____ day of _____ 2022 personally appeared:

NAME

GOVERNMENT ISSUED ID

(Number, Issued On, Issued By)

ALAIN DEL B. PASCUA
Department of Education

JOAN A. ONGONION
RedDot Imaging Philippines, Inc.

Known to me and to me known to be the same persons who executed the foregoing instrument and acknowledge to me that the same is the free and voluntary act and deed of the entities which they respectively represent.

The foregoing instrument is a CONTRACT consisting of six (6) pages (exclusive of attachments), including this page on which this acknowledgment is written and signed by the parties hereto and their instrument witness on the left-hand margin of each and every page hereof.

WITNESS MY HAND AND SEAL on the date and place first above written.

Doc. No. 167;
Page No. 34;
Book No. CXX;
Series of 2022.

NOTARY PUBLIC
ATTY. JOHN EDUARDO TRINIDAD ANG
Notary Public for the City of Manila - Valid 12/31/2021
Notarial Commission No. 20111 - 033 Extended June 30, 2022
21F Midland Plaza Horre - Alameda St. Ermita, Manila.
IBP NO. 166316 - 11/20/2021 for 2022 / Pasig City
PTR NO. 0987534 - 01/03/2022 at Manila
Roll no. 68731 / MCLE Compliance No. VI-0017186

[Signature]
DONA S. PUGALISA
RedDot Imaging Philippines, Inc.'s Witness

[Signature]
JOAN A. ONGONION
RedDot Imaging Philippines, Inc.

[Signature]
ABRAM Y. C. ABANIL
DEPED's Witness

[Signature]
ALAIN DEL B. PASCUA
Department of Education



Technical Specifications
RedDot Imaging Phils, Inc.

LAPTOP'S TECHNICAL SPECIFICATIONS	
Weight	<ul style="list-style-type: none"> • Max 1.6kgs
Processor	<ul style="list-style-type: none"> • 1.6Ghz Based Speed, with Turbo Speed; if 4-Core & 8-Thread 6MB cache <p align="center">OR</p> <ul style="list-style-type: none"> • 2Ghz Based Speed, with Turbo Speed; if 4-Core & 8-Thread 4MB cache
Memory	<ul style="list-style-type: none"> • 2 x 4 GB DDR4 (expandable to 16GB)
Monitor	<ul style="list-style-type: none"> • Screen Size: Min 13" • Resolution: Min 1920 x 1080 (Full HD), 1080p Anti-Glare LED-Backlit OR IPS Technology
Storage	<ul style="list-style-type: none"> • 1 TB SSD
Audio	<ul style="list-style-type: none"> • 6Ω/1W Speaker x 2 Built-in Speakers • ϕ 3.5mm standard headphone jack
Camera	<ul style="list-style-type: none"> • Built-in with shutter cover for privacy
Connectivity	<ul style="list-style-type: none"> • Wireless LAN 802.11 b/g /n/ac • Bluetooth • Built-in wireless screen mirroring
Ports	<ul style="list-style-type: none"> • 1 x USB 3.0 – Type C • 2 x USB 3.0 or 3.1 • 1 x SD / Micro SD • 1 x Combo Audio jack • 1 x HDMI / Micro HDMI <p align="center">(USB conversion/ extension/ adapter are not allowed)</p>
Keyboard	<ul style="list-style-type: none"> • US English Layout • Standard Size • Backlit
Mouse	<ul style="list-style-type: none"> • Optical • Wireless
Headset	<ul style="list-style-type: none"> • Over-the-Head • 3.5mm audio jack connection
Touchpad	<ul style="list-style-type: none"> • Multi-touch or Touch Pad with 2 Buttons

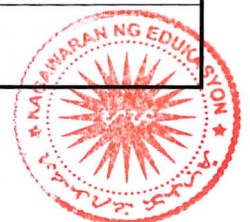

Power Adapter	<ul style="list-style-type: none"> Type-C or Standard AC/DC Adapter
Security	<ul style="list-style-type: none"> Fingerprint Reader Trusted Platform Module (ISO/IEC 11889) integrated to a chip on the computer.
Other Requirements	
<p>The offered brand of the item must be an international brand with at least 5 years' presence at the local market and global presence in the USA, Europe, or Japan market.</p> <p>Microsoft authorized Direct OEM Partner with Global Partner Agreement License Confirmation <i>issued by Microsoft to the Manufacturer</i>, that should indicate the model and product being offered to the agency are authentic and the manufacturer was given the right to pre-install and distribute the Microsoft Licenses under the GPA terms, for the Philippine region, as a local registered named partner in the country.</p>	
Operating System	<ul style="list-style-type: none"> Windows 10 Professional (<i>"Shape the Future"</i>) SKU with antivirus
Applications Software	<ul style="list-style-type: none"> Latest Available Microsoft Office (<i>with installer and licensed key to be provided by DepEd</i>) Other applications to be provided by DepEd
Copy of Software	<ul style="list-style-type: none"> <i>in USB format (bootable and capable of restoring the original system state to another hard disk)</i> to be provided to recipient school and one (1) master copy for each recipient Division thru IT Officer
HDD Partition	<ul style="list-style-type: none"> Drive C (system) and Drive D (data)
Special Requirement	<p>DepEd Logo <i>DepEd 2020 Standard Screen Display Public Schools of the Future (PSOF) EduKalidad</i></p>  <ul style="list-style-type: none"> DepEd Logo shall be programmed in the "Laptop Bios" (<i>displayed during system start-up</i>) DepEd Logo shall be used as "laptop screen Background display / wallpaper" DepEd will provide the logo design in soft copy



DepEd Logo shall be:

- Embossed/Etched at the backside screen display (Cover)

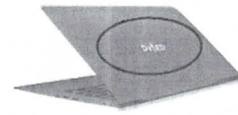

of the

- On the front screen display edge OR keyboard area

- mouse

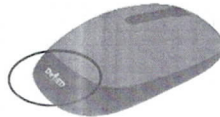

- Brand or Manufacturer's logo should only appear at the laptop base bottom (**backside of the laptop**)

Function Key

- **Any function Key** shall be assigned to restore the Laptop in its original system state in case of breakdown

Helpdesk Contact Information

- **Helpdesk contact information** shall be clearly affixed on the bottom of the laptop (waterproof / scratchproof sticker) device near the laptop's serial number.

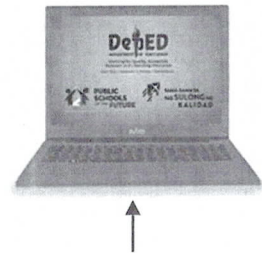

Laptop Casing and Mouse

- Casing and Mouse should be customized
- Color Blue: C, M, Y, K (**71,53,0,12**)

Carrying bag / Laptop bag

Description:

- Color Black
- Ballistic Nylon
- Padded
- Splash Resistant
- Weatherproof Zippers
- With inside and outside pockets
- Adequate for the Laptop model offered
- With DepEd logo embossed or embroidered directly to the bag material as described below:
 - Height: **2 inches**
 - Width: **4 inches**
 - DepEd Logo: Colored



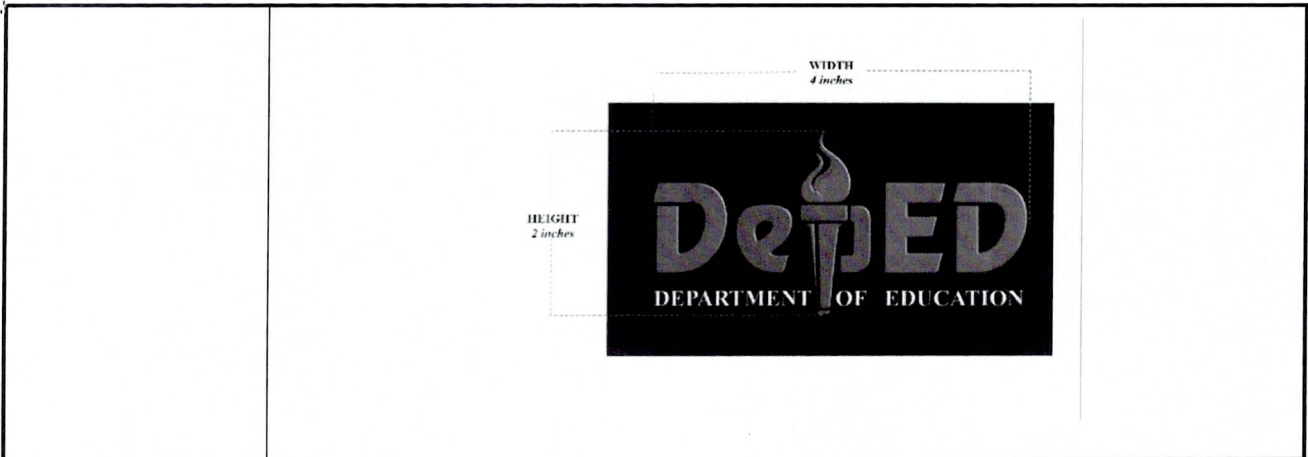

COMPLIANCE STANDARDS

Warranty Support	<ul style="list-style-type: none"> NOT in “end of life” as reflected in the current product line found in the manufacturer’s official website or official product brochure or similar literature and in the Manufacturer’s, Certificate issued for this purpose.
Certification	<ul style="list-style-type: none"> MUST be either ISO 9001:2008 or ISO 9001:2015 certified. MUST be ISO 14001:2004 certified.
	<ul style="list-style-type: none"> Brand of the Laptop must have been in the local and international market for at least five (5) years prior to the scheduled date of bid opening MIL-STD-810G or its equivalent (with test report issued by authorized/accredited third party laboratory).
Ecolabel	<ul style="list-style-type: none"> ISO 14024:1999 or ECMA 370, CE or equivalent (Ecolabel)
Compatibility	<ul style="list-style-type: none"> TO ALLOW integration with future technologies as indicated in a Certificate of Upgradability issued by the manufacturer (i.e. hardware will be compatible to future upgrade of Operating System and/or Software up to one cycle upgrade)
Regulatory Compliance	<ul style="list-style-type: none"> With Approved NTC Certificate

ADDITIONAL REQUIREMENTS

Packaging	<p>The outer packaging must be clearly marked on at least four (4) sides as follows:</p> <p>Side 1 (Front):</p>  <p><i>“Working for Quality, Accessible, Relevant, and Liberating Education!”</i></p> <ul style="list-style-type: none"> Project Name (to be finalized by DepEd) Supplier’s Name and Contact Details
-----------	--



- Recipients Name and Contact Details
- Items inside (name, general description, quantity)

Side 2 (Back):



“Working for Quality, Accessible, Relevant, and Liberating Education!”

- Project Name (to be finalized by DepEd)
- Supplier’s Name and Contact Details
- Recipients Name and Contact Details

Side 3 (Right Rear):

Packaging/Unpacking instructions

- Any special lifting instructions
- Any special handling instruction
- Any relevant HAZCHEM classifications

Side 4 (Left Rear)

Packaging/Unpacking instructions

- Any special lifting instructions
- Any special handling instruction
- Any relevant HAZCHEM classifications

Side 5 (Top)

Others (to be finalized by DepEd)

- Sample Details:

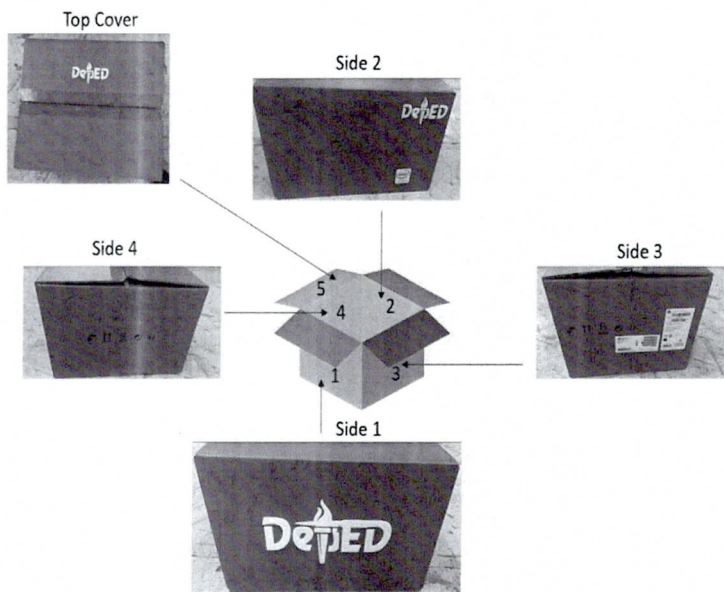

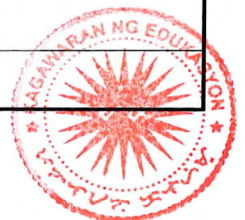

AFTER SALES SUPPORT



- The supplier shall maintain the IT equipment to be functional and in good running condition as a whole package by providing the post implementation support and services including: (i) Operation and management of deployment and (ii) deployment of support technicians for maintenance, troubleshooting and repair purposes.
- Technical support: The Supplier must have affiliated active service centers with personnel possessing any of the following: NC-II in Computer Hardware Servicing, or Licensed Electronics Technician, or Manufacturer's Certified Technician, in at least two (2) locations (in different provinces) in every region where the equipment will be deployed. Signed notarized contract agreement between the bidder and affiliated service partner shall be included in the submission. A valid and current Business permit shall be attached in the agreement. Bidder must submit List of Service Centers with contact details for all applicable Lots joined.
- A three (3) day guarantee to repair the unit/s upon receipt of the request/report of the recipient school. Ensure availability of required spare parts of hardware items for quick response time.
- In case unit/s cannot be repaired within the three (3) day guarantee period, the unit/s must be replaced within the maximum of seven (7) calendar days. A replacement must be of the same branding specifications and shall be delivered prior to pull-out of the defective or unrepairable unit/s.
- The supplier will be requested to provide the Company profiles and Technical Support contact details. Two different mobile numbers from the main telephone companies to be provided and to be operational at least 8 hour/day and 5 days/week (business hours and days).
- Supplier shall set up and manage Helpdesk Support that shall accommodate and process all queries and troubleshooting calls within applicable business hours and business days.
- Supplier shall accommodate and process the recipient's immediate technical support for both hardware and software. Inquiries coming from the emails, phone calls, letters and SMS from different Telco's coming from the recipient school are considered official communication modes and shall be addressed accordingly.
- Supplier shall submit monthly summary reports of received, resolved, pending and closed issues to DepEd ICTS -Technology Infrastructure Division.
- Supplier shall respond reports indicating resolved, pending and closed issues to DepEd ICTS -Technology Infrastructure Division from dcp.recipients@deped.gov.ph.
- DepEd TID-ICTS shall accommodate non-supplier action report at icts.tid@deped.gov.ph.



**EXTERNAL HARD DRIVE
TECHNICAL SPECIFICATIONS**

Capacity	<ul style="list-style-type: none"> • 1TB
Weight	<ul style="list-style-type: none"> • 181 g — 300 g
Storage Media	<ul style="list-style-type: none"> • 2.5" HDD
Rotational Speed	<ul style="list-style-type: none"> • 5400 rpm
System Requirements	<ul style="list-style-type: none"> • MS Windows 7, MS Windows 8, MS Windows 10, Mac OS 10.7 or later, Linux Kernel 2.6.31 or later
Key Feature	<ul style="list-style-type: none"> • With LED light indicator
Interface	<ul style="list-style-type: none"> • Super Speed USB 3.1 Gen 1 / USB 3.0 compliant
Operation	<ul style="list-style-type: none"> • DC 5V (Power supplied through USB)
Accessories	<ul style="list-style-type: none"> • With USB 3.0 cable and product manual in English
Certificates	<ul style="list-style-type: none"> • CE / FCC / BSMI or its equivalent • MIL-STD-810G or its equivalent (with test report issued by authorized/accredited third-party laboratory)
Packaging	<p>The outer packaging must be clearly marked on at least four (4) sides as follows:</p> <p>Side 1 (Front):</p>  <p><i>“Working for Quality, Accessible, Relevant, and Liberating Education!”</i></p> <ul style="list-style-type: none"> • Project Name (to be finalized by DepEd) • Supplier’s Name and Contact Details • Recipients Name and Contact Details • Items inside (name, general description, quantity) <p>Side 2 (Back):</p>  <p><i>“Working for Quality, Accessible, Relevant, and Liberating Education!”</i></p> <ul style="list-style-type: none"> • Project Name (to be finalized by DepEd)

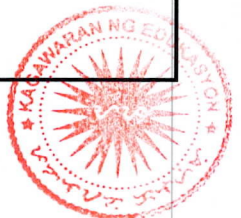

- Supplier's Name and Contact Details
- Recipients Name and Contact Details

Side 3 (Right Rear):

Packaging/Unpacking instructions

- Any special lifting instructions
- Any special handling instruction
- Any relevant HAZCHEM classifications

Side 4 (Left Rear)

Packaging/Unpacking instructions

- Any special lifting instructions
- Any special handling instruction
- Any relevant HAZCHEM classifications

Side 5 (Top)

Others (to be finalized by DepEd)

- Sample Details:

